

**Adco  
Office  
Furniture**  
desking · seating · storage



# COMMERCIAL SEATING CATALOGUE

RECEPTION | TRAINING | EXECUTIVE | OFFICE

Adco Office Furniture 119 Burwood Highway Burwood Victoria 3125  
Phone: 03 9808 4404 Email: [sales@adco.com.au](mailto:sales@adco.com.au) Web: [adco.com.au](http://adco.com.au)



**CHROME ROD CHAIR**  
 - Solid Rod Frame  
 - 2 Piece Fully Upholstered Back  
 - Red, Navy, Black & Charcoal Fabric Options

**16 bottles**

are recycled per metre of fabric used in the upholstery of this chair.

Fabric also stain and water resistant.



\* for more information go to:  
[www.statelinefurniture.com.au](http://www.statelinefurniture.com.au)



**SPENCER**  
 - Stackable  
 - Linkable  
 - 5 Colours  
 - Chrome Frame



**PLUTO**  
 - Lightweight & Strong  
 - Stackable & Linkable  
 - Available in Red/Navy/Black



Stackable & Linkable



**JUPITER**  
 - Poly Back, Fabric Padded Seat  
 - Lightweight & Strong  
 - Stackable & Linkable  
 - Available in Red/Navy/Black



**GALAXY**  
 - Black as standard  
 - 4 leg model stackable

4 Leg



Cantilever



**JACKSON**  
 - Black or Navy  
 - Stackable



**EVE**  
 - Poly Back, Fabric Padded Seat  
 - Lightweight & Strong  
 - Stackable & Linkable  
 - Black only



Black



Red



Blue

Orange

Jordan & Spencer Fabric Options

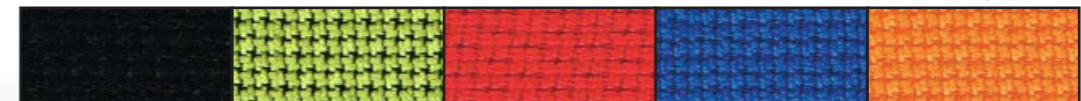



Medium Back



High Back

16 bottles are recycled per metre of fabric used in the upholstery of this chair.

Fabric also stain and water resistant.



This chair has an end of life recyclability of at least 96%



Optional Coathanger

\* for more information go to: [www.statelinefurniture.com.au](http://www.statelinefurniture.com.au)



Black Olive



Red Blue



Orange Silver



16 bottles are recycled per metre of fabric used in the upholstery of this chair.

Fabric also stain and water resistant.



\* for more information go to: [www.statelinefurniture.com.au](http://www.statelinefurniture.com.au)



A

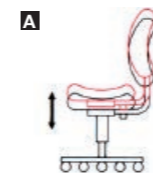

**Pneumatic seat height adjustment**  
Regulates height of chair relative to floor.

B

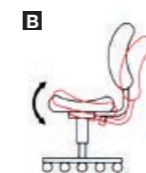

**Seat angle adjustment**  
Seat angle adjusts independently with a single lever.

C

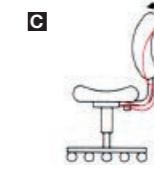

**Back angle adjustment**  
back angle adjusts independently with a single lever.

D

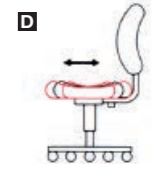

**Sliding seat**  
it provides seat depth adjustment for different user leg lengths.



Navy Black



Olive Red



Blue Orange

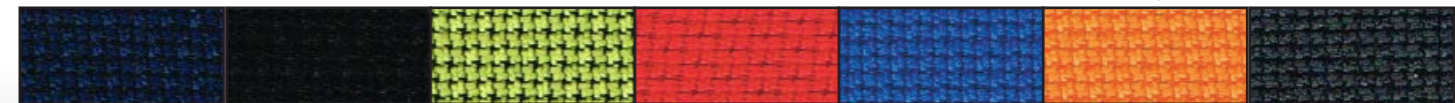



- Ratchet Back Height Adjustment
- Back and Seat Angle Adjustment
- Gas Lift Height Adjustment
- Seat Slide Adjustment



LEVEL 6



LEVEL 6

Seat slide adjustment



\* Chair tested to comply with international standard ANSI/BIFMA x5.1



\* Chair tested to comply with international standard ANSI/BIFMA x5.1

96% This chair has an end of life recyclability of at least 96%



Optional Coathanger

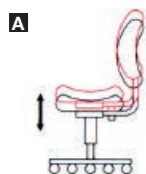
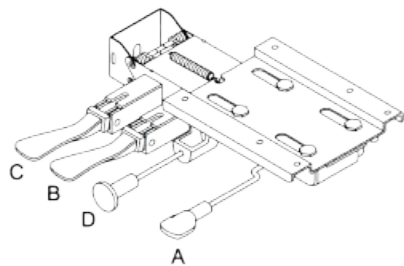

**A**  
**Pneumatic seat height adjustment**  
Regulates height of chair relative to floor.

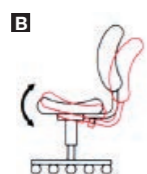

**B**  
**Seat angle adjustment**  
Seat angle adjusts independently with a single lever.



**C**  
**Back angle adjustment**  
back angle adjusts independently with a single lever.

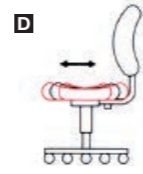

**D**  
**Sliding seat**  
it provides seat depth adjustment for different user leg lengths.

**OPTIONS**

- Polished Alloy Base
- Choice of upholstery fabrics
- Standard Mesh and fabric options
- Available in Medium back and High back



Black Olive Red Blue Orange Silver



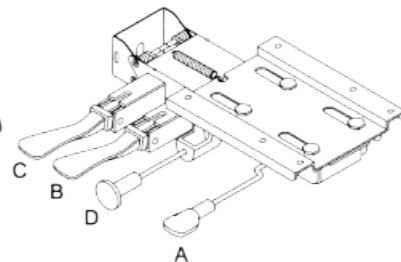

**A**  
**Pneumatic seat height adjustment**  
 Regulates height of chair relative to floor.

**B**  
**Seat angle adjustment**  
 Seat angle adjusts independently with a single lever.

**C**  
**Back angle adjustment**  
 back angle adjusts independently with a single lever.

**D**  
**Sliding seat**  
 it provides seat depth adjustment for different user leg lengths.

**16 bottles** are recycled per metre of fabric used in the upholstery of this chair.

Fabric also stain and water resistant.



\* for more information go to: [www.statelinefurniture.com.au](http://www.statelinefurniture.com.au)



\* Shown with Optional Polished Alloy Base



Navy      Black      Olive      Red      Blue      Orange      Charcoal

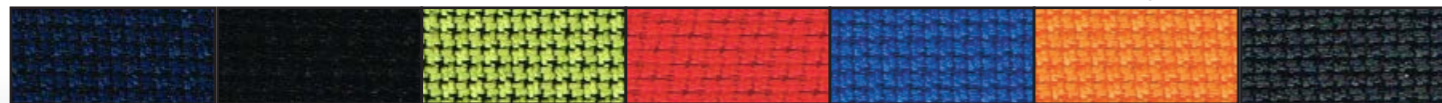

\* Shown with Optional Polished Alloy Base  
 \* Shown with Seat, Mechanism and Arm Variations

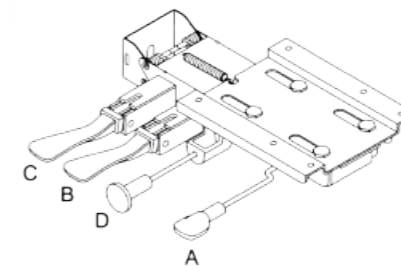

**A**  
**Pneumatic seat height adjustment**  
 Regulates height of chair relative to floor.

**B**  
**Seat angle adjustment**  
 Seat angle adjusts independently with a single lever.

**C**  
**Back angle adjustment**  
 back angle adjusts independently with a single lever.

**D**  
**Sliding seat**  
 it provides seat depth adjustment for different user leg lengths.

**16 bottles** are recycled per metre of fabric used in the upholstery of this chair.

Fabric also stain and water resistant.



\* for more information go to: [www.statelinefurniture.com.au](http://www.statelinefurniture.com.au)



PA01



PA04

- Black Seat Area  
 - Coloured Mesh Back  
 - Fully Ergonomic  
 - Optional Armrests

PA06



PA07

PA09

Mesh Colours

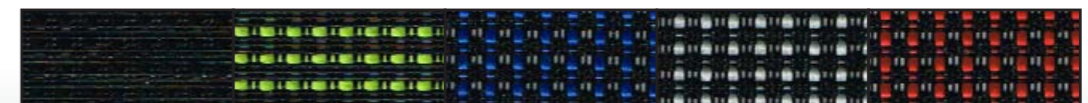



Seat Slide Adjustment Feature



Fully Ergonomic Mechanism including Seat Slide Feature

Optional Polished Alloy Base & Arms

Height and Width Adjustable Armrests

**ENDEAVOUR 101L**

**ENDEAVOUR 101F**

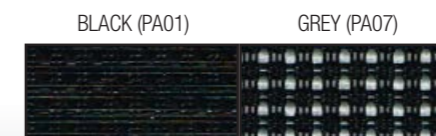
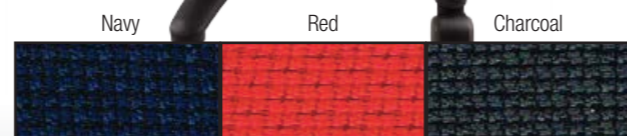

# MESH DELUXE

# MESH DELUXE 'PRO'

# NICHOLAS Mesh Back Executive

Fully Ergonomic 4 Lever Mechanism



\* Headrest on Deluxe not tested by AFRDI



Leather Stitched Seat

Polished Aluminium Base and Chrome Gas

Adjustable Lumbar



Optional Coathanger



Polished Alloy Arms and Base



# MULTIFORM

Fully Ergonomic Leather Executive Chair



\* Chair Mechanism tested to comply with international standard ANSI/BIFMA x5.1

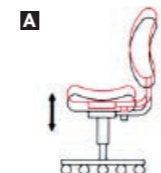
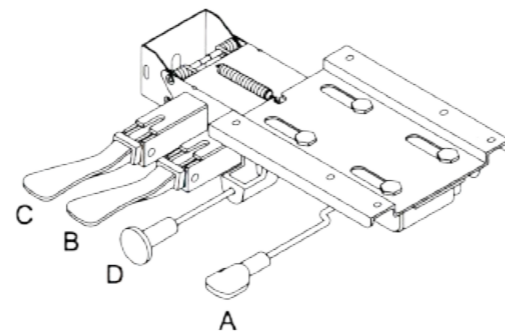

**Pneumatic seat height adjustment**  
Regulates height of chair relative to floor.

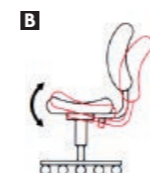

**Seat angle adjustment**  
Seat angle adjusts independently with a single lever.

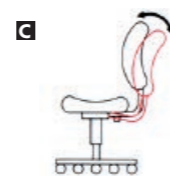

**Back angle adjustment**  
back angle adjusts independently with a single lever.

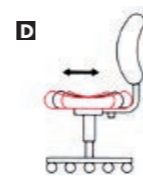

**Sliding seat**  
it provides seat depth adjustment for different user leg lengths.



**Gas Lift Height Adjustment**



**Tilt Lock**



**Tilt Tension**

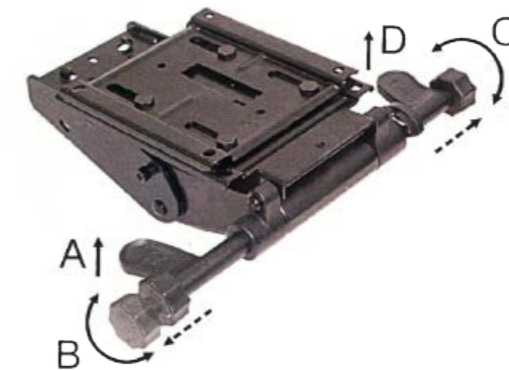

**Seat Slide**

# MIDDY

Navy, Black, Charcoal



# OXLEY | MB

Navy, Black



# PRELUDE



High Back

Black P.U. Upholstery

Polished Aluminium Base and Chrome Gas



Medium Back

# OXLEY | HB

Black PU Visitors Chair



# LAUREN

Black PU Visitors Tub Chair



# SYMPHONY

Clerical/Task



Black P.U. Upholstery

Polished Aluminium Base and Chrome Gas

Cantilever Visitors



Chrome Frame



# BELAIR



- Leather Upholstery
- Polished Aluminium Arm Supports & Base
- Tilt Mechanism
- Padded Leather Armrests
- 3 Year Warranty

# KNEEL ON

