

# ConSet

MANUFACTURERS OF  
ELECTRIC SIT-STAND DESKS



**ConSet Australia**

# HEIGHT ADJUSTABLE HEALTHY WORKING

## A BIT ABOUT ERGONOMICS

### Ergonomics and your health

Every day more and more people are enjoying the many benefits of working while standing.

Numerous studies show that working from a sitting position for extended periods of time is clearly detrimental to your health. In fact in a study cited in the journal *Medicine & Science in Sports & Exercise* found that people who sit for most of the day were 54 % more likely to die of heart attacks. This was a study of 1700 people over a 13 year period. *Men's Health* reports that this statistic is true even if the people in the study were nonsmokers and regular exercisers.

The ConSet line of electrical height adjustable desks gives you the power to transform how you live and work. Standing for portions of your day may be the simplest and most effective way to control weight gain, increase productivity and combat mental fatigue and back pain.

ConSet desks can help to improve your quality of life and help you to live longer.

The benefits are clear and the good news is that ConSet desks are the most affordable desks on the market. Designed and engineered in Denmark they combine high quality, low cost and beautiful design aesthetic. Stationary desks are so yesterday. Enjoy the benefits of ConSet electric height adjustable desks today and for the rest of your life.

Stop sitting down on the job and stand up for your health !

### A world of choices ...

Your options are plentiful when choosing the ConSet desk which is right for you. The desk frame you choose depends on the required maximum load, size and function as well as the interior design.

### Your choice of frame ...

ConSet has desks of different designs and frames with different maximum working loads:

How to choose the right combination? Call your ConSet dealer they will be pleased to help you do that. Consider the LOAD and TASK when choosing the right desk series for you.

### Load

The kg capacity figures show the overall maximum peak lifting capacity of the frame. Load will depend on two factors:

- The weight of the tabletop itself  
*(e.g. a 1500 mm x 800 mm top weighs about 20 kg, whilst a 2000 mm x 800 mm top weighs about 25 kg)*
- The total weight of the items on your desktop.  
*Some desks become loaded over time with books, magazines, filing trays in addition to PC, printer, scanner. If in doubt then always buy the heavier option if your budget allows.*
- The speed of upward travel will be slower as load is increased.

### Task

If you are working using an electronic microscope for example you will need the firmest stability. E.g. a Solid-Line desk will feel more solid standing than a 501-33. On the other hand the 501-33 is adequate for the tasks of writing and using a Personal Computer and it will be much easier to move than a Solid-Line. Other issues to consider could include long working hours or multi-shift use. We want your desk to last well beyond the warranty period. A 100 kg frame used with a 60 kg load will usually last longer than a 80 kg frame with a 60 kg load.



# CONTENTS

**04 501-43**

Rectangular electric sit-stand desks

**06 501-43**

L-shaped electric sit-stand desks

**08 501-33**

Rectangular electric sit-stand desks

**10 501-88**

Rectangular electric sit-stand desks

**14 501-49**

Rectangular electric sit-stand desks

**18 SOLID-LINE**

Rectangular & shaped electric sit-stand desks

**20 SOLID-LINE**

Rectangular & L-shaped electric sit-stand desks

**24 ABOUT CONSET****25 INFORMATION**

Product approvals & warranty

**26 TOP/FRAME  
SELECTION  
GUIDE**

On the following pages you will find our range of height adjustable desks along with their specifications. You are on your way to choosing the right model.

### Frame Specifications

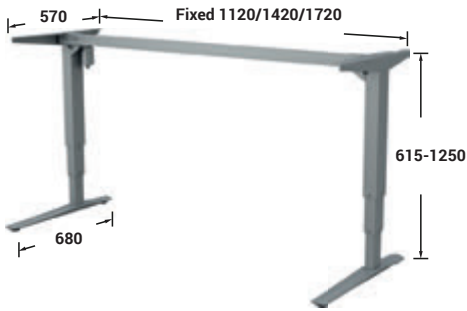

### Standard 25mm Worktop Sizes

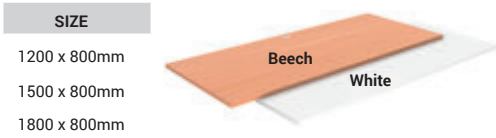

### Standard Frame Colours



### Standard Controller



# 501-43

RECTANGULAR ELECTRIC SIT-STAND DESK

### Frame Specifications (without worktop)

Height range: 615 - 1250mm  
 Max. working load: 100kg frame



501-43 4B172 180-80S3 WM



Fixed rail models only







501-43 4W172 180-80S3 WM

The 501-43 electric height adjustable desk is modern with a minimalistic look. The open frame structure has been designed for strength with a square column and slender foot design. The 501-43 is also available with an adjustable width frame and in 3 colours. The engineered frame makes the 501-43 a strong and durable desk for any office environment.



## 501-43 Rectangular 2-leg Frame Only

SIZE	LEG COLOUR	CODE
1120mm wide Fixed rail	Black	501-43 4B112
	Silver	501-43 4S112
	White	501-43 4W112
1420mm wide Fixed rail	Black	501-43 4B142
	Silver	501-43 4S142
	White	501-43 4W142
1720mm wide Fixed rail	Black	501-43 4B172
	Silver	501-43 4S172
	White	501-43 4W172
1120-1520mm "Flex" Adjustable rail	Black	501-43 4B152A
	Silver	501-43 4S152A
	White	501-43 4W152A
1320-1720 "Flex" Adjustable rail	Black	501-43 4B172A
	Silver	501-43 4S172A
	White	501-43 4W172A

## 501-43 Rectangular 2-leg Complete desk

SIZE	TOP COLOUR	LEG COLOUR	CODE
1200 x 800mm Fixed rail	Beech	Black	501-43 4B112 120-80S3 BM
		Silver	501-43 4S112 120-80S3 BM
		White	501-43 4W112 120-80S3 BM
	White	Black	501-43 4B112 120-80S3 WM
		Silver	501-43 4S112 120-80S3 WM
		White	501-43 4W112 120-80S3 WM
1500 x 800mm Fixed rail	Beech	Black	501-43 4B142 150-80S3 BM
		Silver	501-43 4S142 150-80S3 BM
		White	501-43 4W142 150-80S3 BM
	White	Black	501-43 4B142 150-80S3 WM
		Silver	501-43 4S142 150-80S3 WM
		White	501-43 4W142 150-80S3 WM
1800 x 800mm Fixed rail	Beech	Black	501-43 4B172 180-80S3 BM
		Silver	501-43 4S172 180-80S3 BM
		White	501-43 4W172 180-80S3 BM
	White	Black	501-43 4B172 180-80S3 WM
		Silver	501-43 4S172 180-80S3 WM
		White	501-43 4W172 180-80S3 WM

## Options

Picture	Description	CODE
	Preset Controller with digital display	139250
	Flex Rail, frame length 1120 - 1520mm	SQ137800
	Flex Rail, frame length 1320 - 1720mm	SQ141850

**Frame Specifications**



**Style: Desk + Return**  
Return can be fitted either side

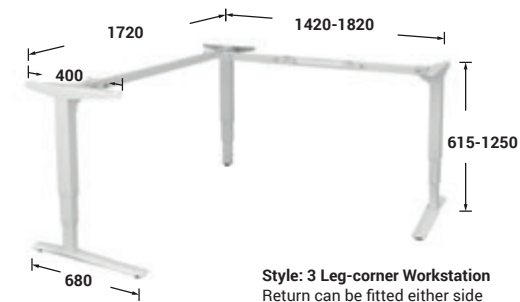

**Style: 3 Leg-corner Workstation**  
Return can be fitted either side

**Standard 25mm Worktop Sizes**

SIZE
1800/800 x 1800/600
1800/800 x 1800/800

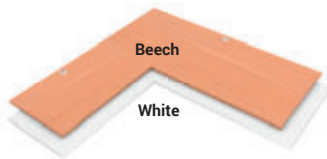

**Standard Frame Colours**

Colour
Black
Silver
White



**Standard Controller**

Style
Single Button Controller



# 501-43

L-SHAPED ELECTRIC SIT-STAND DESK

**Frame Specifications (without worktop)**

Height range: 615 - 1250mm  
Max. working load: 90kg frame



501-43 4W172-172A 180-80S3 100-80S3 WM







501-43 4S172-172A 180-80S3 100-80S3 BM

The 501-43 electric height adjustable corner desk is modern with a minimalistic look. The open frame structure has been designed for strength with a square column and slender foot design. The 501-43 corner frame suits a variety of working configurations and is available in 3 colours. The engineered frame makes the 501-43 a strong and durable desk for any office environment.

## 501-43 L-Shape, 3-leg, Frame Only

Fixed rail for main top, flex rail for return top

SIZE	LEG COLOUR	CODE
1720 x 1420-1820mm	Black	501-43 4B172-172A
	Silver	501-43 4S172-172A
	White	501-43 4W172-172A

## 501-43 L-Shape, 3 Leg-complete Desk & Return

Desk top 800mm deep, return top 600mm deep

SIZE	TOP COLOUR	LEG COLOUR	CODE
1800 x 1800mm return 600 deep	Beech	Black	501-43 4B172-172A 180-80S3 100-60S3 BM
		Silver	501-43 4S172-172A 180-80S3 100-60S3 BM
		White	501-43 4W172-172A 180-80S3 100-60S3 BM
	White	Black	501-43 4B172-172A 180-80S3 100-60S3 WM
		Silver	501-43 4S172-172A 180-80S3 100-60S3 WM
		White	501-43 4W172-172A 180-80S3 100-60S3 WM

## 501-43 L-Shape, 3 Leg-complete Corner Workstation

Desk top 800mm deep, return top 800mm deep

SIZE	TOP COLOUR	LEG COLOUR	CODE
1800 x 1800mm return 800 deep	Beech	Black	501-43 4B172-172A 180-80S3 100-80S3 BM
		Silver	501-43 4S172-172A 180-80S3 100-80S3 BM
		White	501-43 4W172-172A 180-80S3 100-80S3 BM
	White	Black	501-43 4B172-172A 180-80S3 100-80S3 WM
		Silver	501-43 4S172-172A 180-80S3 100-80S3 WM
		White	501-43 4W172-172A 180-80S3 100-80S3 WM

## Options

Picture	Description	CODE
	Preset Controller with digital display	139250

**Note:** Main top is always 1800mm wide, this rail is fixed length. The return top has a flex rail to suit an overall depth of 1500 - 2000mm

### Frame Specifications

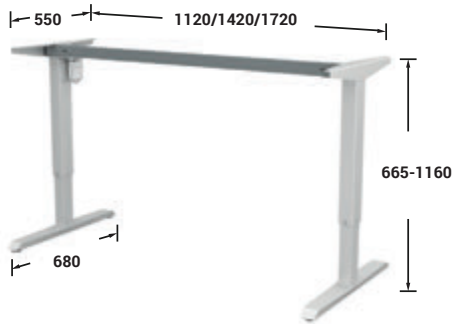

### Standard 25mm Worktop Sizes

SIZE
1200 x 800mm
1500 x 800mm
1800 x 800mm

Beech White

### Standard Frame Colours

Colour
Black
Silver
White

### Standard Controller

Style
Single Button Controller

# 501-33

RECTANGULAR ELECTRIC SIT-STAND DESK

**Frame Specifications (without worktop)**  
 Height range: 665 - 1160mm  
 Max. working load: 80kg frame



501-33 4B142 150-80S3 WM





501-33 4W172 180-80S3 BM

Stylish, modern and open frame design. The square columns and modern look makes this desk suitable for all office and meeting room environments. The 501-33 is available with an adjustable width and in different colours. Quick and easy to assemble, a complete desk at an affordable price.– It's that easy. The height ranges from 655mm to 1160mm with 80 kg of lifting capacity



## 501-33 Rectangular 2 Leg-frame Only

SIZE	LEG COLOUR	CODE
1120mm wide Fixed rail	Black	501-33 4B112
	Silver	501-33 4S112
	White	501-33 4W112
1420mm wide Fixed rail	Black	501-33 4B142
	Silver	501-33 4S142
	White	501-33 4W142
1720mm wide Fixed rail	Black	501-33 4B172
	Silver	501-33 4S172
	White	501-33 4W172
1120-1520mm "Flex" Adjustable rail	Black	501-33 4B152A
	Silver	501-33 4S152A
	White	501-33 4W152A
1320-1720mm "Flex" Adjustable rail	Black	501-33 4B172A
	Silver	501-33 4S172A
	White	501-33 4W172A

## 501-33 Rectangular 2 Leg-Complete desk

SIZE	TOP COLOUR	LEG COLOUR	CODE
1200 x 800mm Fixed rail	Beech	Black	501-33 4B112 120-80S3 BM
		Silver	501-33 4S112 120-80S3 BM
		White	501-33 4W112 120-80S3 BM
	White	Black	501-33 4B112 120-80S3 WM
		Silver	501-33 4S112 120-80S3 WM
		White	501-33 4W112 120-80S3 WM
1500 x 800mm Fixed rail	Beech	Black	501-33 4B142 150-80S3 BM
		Silver	501-33 4S142 150-80S3 BM
		White	501-33 4W142 150-80S3 BM
	White	Black	501-33 4B142 150-80S3 WM
		Silver	501-33 4S142 150-80S3 WM
		White	501-33 4W142 150-80S3 WM
1800 x 800mm Fixed rail	Beech	Black	501-33 4B172 180-80S3 BM
		Silver	501-33 4S172 180-80S3 BM
		White	501-33 4W172 180-80S3 BM
	White	Black	501-33 4B172 180-80S3 WM
		Silver	501-33 4S172 180-80S3 WM
		White	501-33 4W172 180-80S3 WM

## Options

Picture	Description	CODE
	Preset Controller with digital display	139250
	Flex Rail, frame length 1120 - 1520mm	SQ137800
	Flex Rail, frame length 1320 - 1720mm	SQ141850

### Frame Specifications

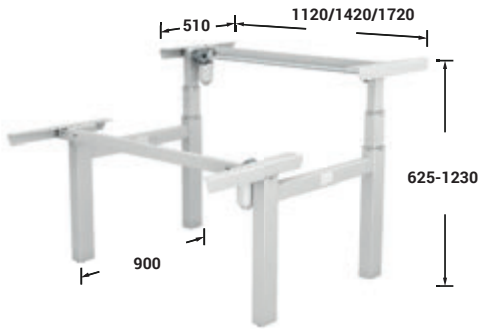

### Standard 25mm Worktop Sizes

**SIZE**

- 1200 x 800mm
- 1500 x 800mm
- 1800 x 800mm

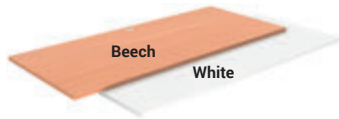

### Standard Frame Colours

**Colour**

White



### Standard Controller

**Style**

Single Button  
Controller



# 501-88

RECTANGULAR ELECTRIC SIT-STAND DESK

### Frame Specifications (without worktop)

Height range: 625 - 1230mm  
Max. working load: 100kg frame





501-88 4B172 180-80S3 WM

Functional bench desk with an open frame design. The 501-88 is very suitable for large office environments and the design makes it easy to separate the desks from each other with a partition screen. Minimize cable clutter and mount a cable tray, which also makes cleaning a lot easier. 501-88 is a functional, robust and durable desk for all purposes.

## 501-88 Back to Back frame only, (2 workpoints)





SIZE	LEG COLOUR	CODE
1120mm wide Fixed rail	White	501-88 4W112
1420mm wide Fixed rail	White	501-88 4W142
1720mm wide Fixed rail	White	501-88 4W172
1120-1520mm "Flex" Adjustable rail	White	501-88 4W152A
1320-1720mm "Flex" Adjustable rail	White	501-88 4W172A

## 501-88 Back to back, two complete desks

### Fixed length rails

SIZE	TOP COLOUR	LEG COLOUR	CODE
1200 x 800mm Fixed rail	Beech	White	501-88 4W112 120-80S3 BM
	White	White	501-88 4W112 120-80S3 WM
1500 x 800mm Fixed rail	Beech	White	501-88 4B142 150-80S3 BM
	White	White	501-88 4S142 150-80S3 BM
1800 x 800mm Fixed rail	Beech	White	501-88 4W172 180-80S3 BM
	White	White	501-88 4B172 180-80S3 WM

## Options

Picture	Description	CODE
	Preset Controller with digital display	139250
	Flex Rail, frame length 1120 - 1520mm	SQ137800
	Flex Rail, frame length 1320 - 1720mm	SQ141850
	Cable tray	
	Partition screen	



**“  
A stylish frame with elegant  
round columns.”**





**501-49**



### Frame Specifications

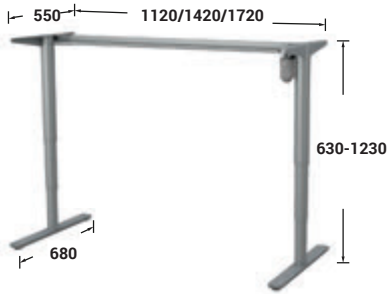

### Standard 25mm Worktop Sizes

SIZE
1200 x 800mm
1500 x 800mm
1800 x 800mm

Beech White

### Standard Frame Colours

Colour
Black
Silver
White

Black Silver White

### Standard Controller

Style
Single Button Controller

# 501-49

## RECTANGULAR ELECTRIC SIT-STAND DESK

### Frame Specifications (without worktop)

Height range: 630-1230mm  
Max. working load: 100kg frame



501-49 4S172 180-80S3 WM





501-49 4B172 180-80S3 WM

An elegant desk the 501-49 is a 2 column design which will complement any office environment. The round columns are designed with a double telescopic mechanism which allows more overlap between the tubes, resulting in improved travel and stability. Available in 3 colours and a variety of sizes, the 501-49 is an elegant frame suitable for many applications.

## 501-49 Rectangular 2 leg frame only



SIZE	LEG COLOUR	CODE
1120mm wide Fixed rail	Black	501-49 4B112
	Silver	501-49 4S112
	White	501-49 4W112
1420mm wide Fixed rail	Black	501-49 4B142
	Silver	501-49 4S142
	White	501-49 4W142
1720mm wide Fixed rail	Black	501-49 4B172
	Silver	501-49 4S172
	White	501-49 4W172
1120-1520mm "Flex" Adjustable rail	Black	501-49 4B152A
	Silver	501-49 4S152A
	White	501-49 4W152A
1320-1720mm "Flex" Adjustable rail	Black	501-49 4B172A
	Silver	501-49 4S172A
	White	501-49 4W172A

## 501-49 Rectangular 2 leg complete desk

Fixed length rail

SIZE	TOP COLOUR	LEG COLOUR	CODE
1200 x 800mm Fixed rail	Beech	Black	501-49 4B112 120-80S3 BM
		Silver	501-49 4S112 120-80S3 BM
		White	501-49 4W112 120-80S3 BM
	White	Black	501-49 4B112 120-80S3 WM
		Silver	501-49 4S112 120-80S3 WM
		White	501-49 4W112 120-80S3 WM
1500 x 800mm Fixed rail	Beech	Black	501-49 4B142 150-80S3 BM
		Silver	501-49 4S142 150-80S3 BM
		White	501-49 4W142 150-80S3 BM
	White	Black	501-49 4B142 150-80S3 WM
		Silver	501-49 4S142 150-80S3 WM
		White	501-49 4W142 150-80S3 WM
1800 x 800mm Fixed rail	Beech	Black	501-49 4B172 180-80S3 BM
		Silver	501-49 4S172 180-80S3 BM
		White	501-49 4W172 180-80S3 BM
	White	Black	501-49 4B172 180-80S3 WM
		Silver	501-49 4S172 180-80S3 WM
		White	501-49 4W172 180-80S3 WM

## Options

Picture	Description	CODE
	Preset Controller with digital display	139250
	Flex Rail, frame length 1120 - 1520mm	SQ137800
	Flex Rail, frame length 1320 - 1720mm	SQ141850

**“  
One motor does it ALL!”**







**501-43**



### Frame Specifications

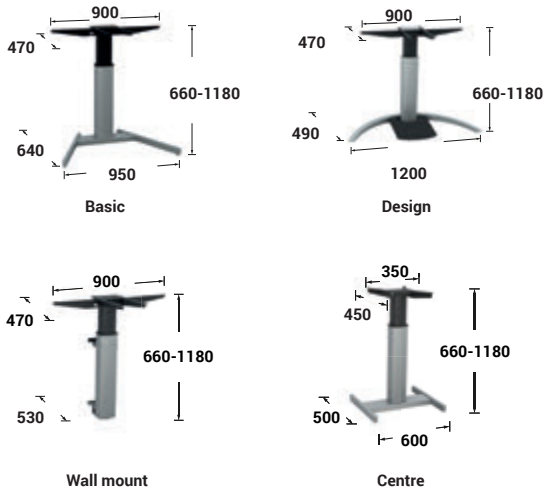

### Standard 25mm Worktop Sizes

- | SIZE            |
|-----------------|
| 600 x 600       |
| 1000 x 600      |
| 1200 x 600      |
| 1000 x 800      |
| 1200 x 800      |
| Heart 1170      |
| Angle 120° 1380 |
| Curve 120° 1400 |

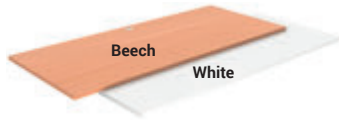

### Standard Frame Colours

- | Colour |
|--------|
| Black  |
| Silver |



### Standard Controller

- | Style                    |
|--------------------------|
| Single Button Controller |



# Solid-Line

RECTANGULAR ELECTRIC SIT-STAND DESK

### Frame Specifications (without worktop)

Overall height range: 660-1180mm  
 Max. working load: 100kg frame



501-19 4B120 140S3 BM

501-19 4S095 117S3 BM





501-19 4S060 100-60S3 BM

501-19 4SW 100-80S3 BM



## Solid-Line Single column frame only

SIZE	LEG COLOUR	CODE
600w Centre	Black	501-19 4B060
	Silver	501-19 4S060
950w Basic	Black	501-19 4B095
	Silver	501-19 4S095
1200w Design	Black	501-19 4B120
	Silver	501-19 4S120
900w Wall mount	Black	501-19 4BW
	Silver	501-19 4SW

## Solid-Line Single column complete desk

SIZE	TOP COLOUR	LEG COLOUR	CODE
600 x 600 Centre	Beech	Black	501-19 4B060 060-60S3 BM
		Silver	501-19 4S060 060-60S3 BM
	White	Black	501-19 4B060 060-60S3 WM
		Silver	501-19 4S060 060-60S3 WM
1000 x 600 Centre	Beech	Black	501-19 4B060 100-60S3 BM
		Silver	501-19 4S060 100-60S3 BM
	White	Black	501-19 4B060 100-60S3 WM
		Silver	501-19 4S060 100-60S3 WM
1000 x 800 Wall mount	Beech	Black	501-19 4BW 100-80S3 BM
		Silver	501-19 4SW 100-80S3 BM
	White	Black	501-19 4BW 100-80S3 WM
		Silver	501-19 4SW 100-80S3 WM
1200 x 800 Design	Beech	Black	501-19 4B120 120-80S3 BM
		Silver	501-19 4S120 120-80S3 BM
	White	Black	501-19 4B120 120-80S3 WM
		Silver	501-19 4S120 120-80S3 WM
Heart shape Basic	Beech	Black	501-19 4B095 117S3 BM
		Silver	501-19 4S095 117S3 BM
	White	Black	501-19 4B095 117S3 WM
		Silver	501-19 4S095 117S3 WM
Angle 120° 1380 Design	Beech	Black	501-19 4B120 138S3 BM
		Silver	501-19 4S120 138S3 BM
	White	Black	501-19 4B120 138S3 WM
		Silver	501-19 4S120 138S3 WM
Curve 120° 1400 Design	Beech	Black	501-19 4B120 140S3 BM
		Silver	501-19 4S120 140S3 BM
	White	Black	501-19 4B120 140S3 WM
		Silver	501-19 4S120 140S3 WM

## Options

Picture	Description	CODE
	Tilt device	501-19 VHEL
	Set of 4 castors	501-19 HXXX
	Battery, 24V	BAT-24-1,7



### Frame Specifications

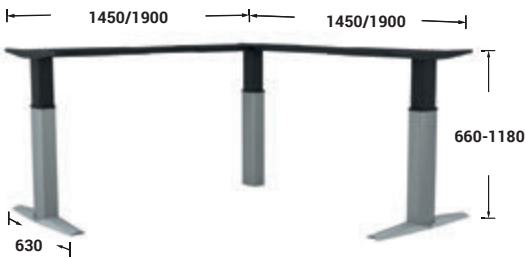
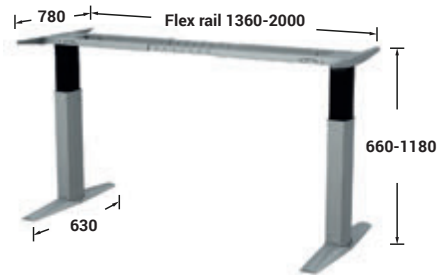

### Standard 25mm Worktop Sizes

SIZE
1600 x 800
1800 x 800
2000 x 800
1800/800 x 1800/600
1800/800 x 1800/800
2000/800 x 2000/600
2000/800 x 2000/800

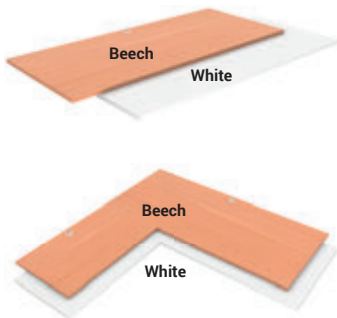

### Standard Frame Colours

Colour
Black
Silver



### Standard Controller

Style
Single Button Controller



# Solid-Line

RECTANGULAR ELECTRIC SIT-STAND DESK

### Frame Specifications (without worktop)

Overall height range: 660-1180mm  
 Max. working load: 200 - 400kg frame



501-23 4S200 180-80S3 BM

501-23 4S190-190A 200-80S3 120-80S3 WM







### Solid-Line Rectangular 2 leg frame only

SIZE	FRAME COLOUR	CODE
1320-2000mm "Flex" Adjustable rail	Black	501-23 4B200
	Silver	501-23 4S200

### Solid-Line L-shape, 3 leg frame only

SIZE	FRAME COLOUR	CODE
Corner (adjustable rails)	Black	501-23 4B190-190A
	Silver	501-23 4S190-190A

### Solid-Line Straight, 3 leg frame only

SIZE	FRAME COLOUR	CODE
Long frame (adjustable rails)	Black	501-23 4B400K
	Silver	501-23 4S400K

### Solid-Line Rectangular 2 leg complete desk

SIZE	TOP COLOUR	LEG COLOUR	CODE	
1600 x 800	Beech	Black	501-23 4B200 160-80S3 BM	
		Silver	501-23 4S200 160-80S3 BM	
	White	Black	501-23 4B200 160-80S3 WM	
		Silver	501-23 4S200 160-80S3 WM	
1800 x 800	Beech	Black	501-23 4B200 180-80S3 BM	
		Silver	501-23 4S200 180-80S3 BM	
	White	Black	501-23 4B200 180-80S3 WM	
		Silver	501-23 4S200 180-80S3 WM	
	2000 x 800	Beech	Black	501-23 4B200 200-80S3 BM
			Silver	501-23 4S200 200-80S3 BM
White	Black	501-23 4B200 200-80S3 WM		
	Silver	501-23 4S200 200-80S3 WM		

### Solid-Line L-shape 3 leg complete desk and return

Desk top 800mm deep, return top 600mm deep

SIZE	TOP COLOUR	LEG COLOUR	CODE
1800 x 1800 return 600 deep	Beech	Black	501-23 4B190-190A 180-80S3 100-60S3 BM
		Silver	501-23 4S190-190A 180-80S3 100-60S3 BM
	White	Black	501-23 4B190-190A 180-80S3 100-60S3 WM
		Silver	501-23 4S190-190A 180-80S3 100-60S3 WM
2000 x 2000 return 600 deep	Beech	Black	501-23 4B190-190A 200-80S3 120-60S3 BM
		Silver	501-23 4S190-190A 200-80S3 120-60S3 BM
	White	Black	501-23 4B190-190A 200-80S3 120-60S3 WM
		Silver	501-23 4S190-190A 200-80S3 120-60S3 WM

### Solid-Line L-shape 3 leg complete corner workstation

Desk top 800mm deep, return top 800mm deep

SIZE	TOP COLOUR	LEG COLOUR	CODE
1800 x 1800 return 800 deep	Beech	Black	501-23 4B190-190A 180-80S3 100-80S3 BM
		Silver	501-23 4S190-190A 180-80S3 100-80S3 BM
	White	Black	501-23 4B190-190A 180-80S3 100-80S3 WM
		Silver	501-23 4S190-190A 180-80S3 100-80S3 WM
2000 x 2000 return 800 deep	Beech	Black	501-23 4B190-190A 200-80S3 120-80S3 BM
		Silver	501-23 4S190-190A 200-80S3 120-80S3 BM
	White	Black	501-23 4B190-190A 200-80S3 120-80S3 WM
		Silver	501-23 4S190-190A 200-80S3 120-80S3 WM

501-23 4B200 180-80S3 WM

501-23 4S190-190A 180-80S3 100-60S3 WM



**“  
Design and function perfectly  
combined.”**







**501-33**



## CONSET – A DANISH COMPANY

We began with the idea to develop and manufacture high quality electric height adjustable desks and to make them affordable so more people could experience the benefits of sit / stand desks.

The company has succeeded quite well and now has distribution and subsidiaries throughout the world.

ConSet at its core is an engineering company that develops the products down to the smallest component. Since every component of a ConSet desk is developed and produced by the company including our patented drive system we are able to control our costs and achieve our goal.

Quality, consistency, value and support is what you will experience with ConSet at every level of our organization.

### Environment

At ConSet we think it is important to minimize environmental impacts.

We want to take responsibility for ensuring that our products are made respecting the environment.

We do this in several ways :

- Our wood products are FSC, which is a guarantee that you can buy our tabletops and other wood products in good conscience. FSC criteria prohibits conversion of forests or any other natural habitat.

### CE marking

All ConSet electric height adjustable desk frames are CE marked in collaboration with the Technological Institute

in Denmark. CE marking is a requirement for height adjustable desk frames and it allows you to be sure that the producer has been through all aspects of security risk.

Furthermore, our power supplies are GS-tested ( German standard ).

### ConSet on the web

Constantly we work to ensure that our website is functional and useful to our customers.

All relevant information and specifications are available on our website and acts as a supplement to our printed material including :

- Assembly instructions
- Drawings ( PDF- and CAD-files )
- Technical specifications
- Videos with assembly instructions
- Images for download



# ABOUT US

- All electronic components meet RoHS framework for the reduction of hazardous substances in electronics, whereby the environmental impact is minimized.
- From January 2010 a new law concerning standby consumption took effect. All our sit / stand frames meet the legal requirements for this.

Read more about the environment on

[www.consetaustralia.com.au](http://www.consetaustralia.com.au)



## PRODUCT APPROVALS

### Dimensional requirements:

EN 527-1:

All ConSet products meet the necessary requirements within the following relevant categories:

### **Office furniture – Workplaces and desks – Part 1 : Dimensions**

This means that the products meet all requirements for a healthy work environment, ie. leg room, height, depth, etc.

### Strength, durability and stability:

EN 527-2:

### **Office furniture – Workplaces and desks – Part 2 : Mechanical safety requirements**

A product standard that describes all basic safety requirements and ensures that the tables meet all requirements for physical exertion, and that all mechanical requirements are adhered to.

EN 527-3:

### **Office furniture – Workplaces and desks – Part 3 : Methods of test for the determination of the stability and the mechanical strength of the structure**

Methods of testing for the determination of the stability and mechanical strength of the structure. A standard for product approval, where the product goes through a variety of tests to comply with the requirements of EN 527-2. Within desks these are technically focused on the strength of horizontal and vertical loading fatigue and tipping.

## WARRANTY

**5 year warranty**















**5 years**

On motor and frame

**\*Warranty covers replacement parts only, it does not cover onsite labour or freight costs**

**\*501-43 straight fixed rail only**

## FRAME / TOP SELECTION GUIDE

Range	Colour	Lifting capacity	page #	CORNER  3 LEG FRAMES									
				1500/800 1 500/600 (27kg)	1600/800 1 600/600 (29.5kg)	1600/800 1 600/800 (32.5kg)	1800/800 1 800/600 (34.5kg)	1800/800 1 800/800 (38kg)	2000/800 1 800/600 (37kg)	2000/800 1 800/800 (40.5kg)	2000/800 2 000/600 (39kg)	2000/800 2 000/800 (43kg)	
501-43	Black Silver White	90kg	6										
501-33	Black Silver White	N/A	N/A										
501-88	White	N/A	N/A										
501-49	Black Silver White	N/A	N/A										
Solid-Line	Black Silver	200 - 400kg	18/20										





**ConSet**

CONSET BROCHURE 2017

ADDRESS

23 Tova Drive, Carrum Downs  
Victoria 3201, Australia

PHONE

03 9775 0425

WEB

[consetaustralia.com.au](http://consetaustralia.com.au)

EMAIL

[sales@consetaustralia.com.au](mailto:sales@consetaustralia.com.au)