

**AFFORDABLE**

solution conveniently

**FLAT -  
PACKED**

Imported in

**HIGH - END  
QUALITY**



January 2019 Issue

**A C C E N T**



GST applies to all prices effective from 1st Jan 2018

BOARDROOM

**P20**



STORAGE

**P26**



COLLECTIONS

**P30**



DESKS

**P08**



WORKSTATION

**P16**



SEATING

**P22**





MEETING

**P11**



RECEPTION

**P05**



METAL FRAMES

**P44**



ACCENT RANGE

# INDEX



EDUCATION

**P28**



ACCENT  
for the  
**A.S.A.P**  
Affordable Solution  
Conveniently  
**FLAT - PLACKED**  
in High - End  
**QUALITY**



ACCESSORIES

**P48**

How The Accent Works

STEP  
**01**

Choose your  
FINISHED PRODUCT

Choose your finished  
product or go to Step 2

STEP  
**02**

Choose your  
TOP / BASE

Choose your Top  
or Base

STEP  
**03**

Choose your  
DIMENSION

Choose the  
dimension for your  
product

STEP  
**04**

Choose your  
COLOUR

Choose your colour  
for your product







## Reception Desk & Armchair



### TRILUX

45 degree Birds Mouth Joined Hob & Feature Panel  
Adjustable feet & three cable holes  
Finishes: Wenge + White

CODE	DIMENSION
IFTRRPCT	2216W x 820D x 1153H
OPTION	Fully Assembled LED Light under 1200W Feature Panel

### EADU ARMCHAIR

BU MU CH

Seat & Back: Fabric Upholstered  
Base: Black Powder-coated Steel  
Seat Height: 390H

CODE	DIMENSION
ICEDAR	690W x 780D x 830H

ICKM1SGRGR - 1 Seater



ICKM2SGRGR - 2 Seater



KAMINO

GR

Seat: Fabric Upholstered  
 Back: Dark Grey PU  
 Base: Steel Chrome Finish  
 Seat Height: 440H

CODE	DIMENSION
ICKM1SGRGR	880W x 610D x 760H
ICKM2SGRGR	1380W x 610D x 760H



BOON

MG

Seat & Back: Fabric Upholstered  
 Base: Polished Stainless Steel  
 Seat Height: 410H

CODE	DIMENSION
ICBOSMG	1600W x 800D x 1200H



VERONA 1 SEATER

Seat & Back: Synthetic Leather  
 Base: Steel Chrome Finish  
 Seat Height: 410H

CODE	DIMENSION
ICVE1SL	840W x 720D x 790H



VERONA 2 SEATER

Seat & Back: Synthetic Leather  
 Base: Steel Chrome Finish  
 Seat Height: 410H

CODE	DIMENSION
ICVE2SL	1390W x 720D x 790H



VERONA 3 SEATER

Seat & Back: Synthetic Leather  
 Base: Steel Chrome Finish  
 Seat Height: 410H

CODE	DIMENSION
ICVE3SL	1940W x 720D x 790H

Coffee Table



SOTO GLASS - SQUARE

PO

Top: 12mm Tempered Clear Glass  
 Base: 38mm Square Tube

CODE	DIMENSION
IFSOSQ06PO	600W x 600D x 400H
OPTION	Fully Assembled



SOTO GLASS - RECTANGLE

PO

Top: 12mm Tempered Clear Glass  
 Base: 38mm Square Tube

CODE	DIMENSION
IFSOSRE12PO	1200W x 600D x 400H
OPTION	Fully Assembled





SG GR  
Limited Edition

KONNECT CORNER

Seat & Back: Fabric Upholstered  
Base: Steel Chrome Finish  
Seat Height: 420H



CODE	DIMENSION
ICKOLBGR	750W x 750D x 710H



SG GR  
Limited Edition

KONNECT MIDDLE

Seat & Back: Fabric Upholstered  
Base: Steel Chrome Finish  
Seat Height: 420H



CODE	DIMENSION
ICKOSBGR	550W x 750D x 710H



SG GR  
Limited Edition

KONNECT OTTOMAN

Seat & Back: Fabric Upholstered  
Base: Steel Chrome Finish  
Seat Height: 420H



CODE	DIMENSION
ICKOOTGR	550W x 750D x 420H

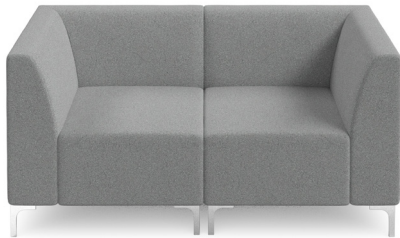

CONFIGURATION - A

Konnect Corner: x 2

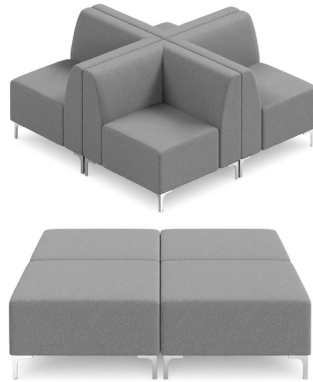

CONFIGURATION - B

Konnect Corner: x 4  
Konnect Ottoman: x 4

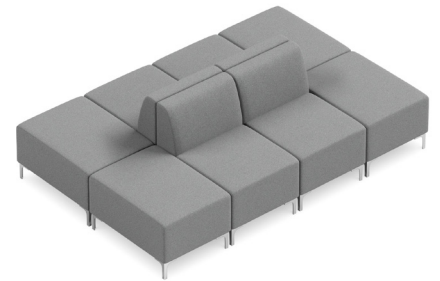

CONFIGURATION - C

Konnect Middle: x 4  
Konnect Ottoman: x 4

Coffee Table



VERSE

Top: Melamine Thickness 25mm  
Base: Ø63 Column & Ø400 Base

PART	SHAPE	CODE	DIMENSION	COLOUR
TOP	Round	IFRDT005	Ø550	WT
BASE	Side view	IMVSTBA Suit Top: IFRDT006	Ø400 x 425H	PO
OPTION	Fully Assembled			



AIR-SQUARE

Top: Melamine Thickness 25mm  
Base: 10 x 20mm Stainless Steel Tube

PART	SHAPE	CODE	DIMENSION	COLOUR
TOP	Round	IFRDT005	Ø550	WT
BASE	Side view	IMCRSQ06PO Suit Top: IFRDT006	550W x 550D x 425H	PO
OPTION	Fully Assembled			



# DESKS



\*Electric Accessories - Page 42\*

SOLO - 101



Top: Melamine 25mm Thickness

Base: Electric Height Adjustable

70 x 70 Heavy Duty Steel Tube

Hydraulic System



Master Controller



Load Max 70kg

Feet Depth 750mm with Adjustable Glide

PART	SHAPE	CODE	DIMENSION	COLOUR
TOP	Rectangle	IFRETO15	1500W x750D	CB CW GR WT
		IFRETO18	1800W x900D	
BASE	Side view	IMSESO101 Suit Top: IFRETO15 IFRETO18	1100 ~ 1800W x 750D x 625 ~ 1275H	WT
OPTION	Fully Assembled			



PLAZA

Top: Melamine 25mm Thickness

Base: 50mm Square Tube Legs

Adjustable Feet

PART	SHAPE	CODE	DIMENSION	COLOUR
TOP	Rectangle	IFRETO15	1500W x750D	CB CW GR WT
		IFRETO18	1800W x900D	
BASE	Side view	IMPZS1TFTB07 Suit Top: IFRETO15	1500 ~ 2100W x 750D x 700H	WT
		IMPZS1TFTB09 Suit Top: IFRETO18	1500 ~ 2100W x 900D x 700H	
OPTION	Fully Assembled			



VISTA

Top: Melamine 25mm Thickness

Base: 40 x 70mm Rectangle Tube Side Legs

Adjustable Feet

PART	SHAPE	CODE	DIMENSION	COLOUR
TOP	Rectangle	IFRETO18	1800W x 900D	CB CW GR WT
BASE	Side view	IMVTS1TFTB09 Suit Top: IFRETO18	1500 ~ 2100W x 900D x 700H	WT
OPTION	Fully Assembled			



\*For more Frame Detail Description - Refer to page 44\*



## DIAMOND

Top: Melamine 25mm Thickness  
Base: 70mm X 15~35mm Steel Beam  
Adjustable Feet



## DELTA NOUVEAU

Top: Melamine 25mm Thickness  
Base: 60 x 15mm Stainless Steel Tube  
Black ABS Foot Pads



## FORUM

Top: Melamine 25mm Thickness  
Base: 55mm Triangular Tube Side Legs  
Adjustable Feet



## LETO

Top: Melamine 25mm Thickness  
Base: Tech Height Adjustable  
\*Beams modified according to requirements\*



## K-LITE

Top: Melamine 25mm Thickness  
Base: Ø50 Round Steel Tube  
Adjustable Feet

PART	SHAPE	CODE	DIMENSION	COLOUR
TOP	Rectangle	IFRETO15	1500W x 750D	CB CW GR WT
		IFRETO18	1800W x 900D	
BASE	Side view	IMDM1TB1507 Suit Top: IFRETO15	1500W x 750D x 707H	WT
		IMDM1TB1809 Suit Top: IFRETO18	1800W x 900D x 707H	
OPTION		Fully Assembled		

PART	SHAPE	CODE	DIMENSION	COLOUR
TOP	Rectangle	IFRETO18	1800W x 900D	CB CW GR WT
BASE	Side view	IMDNBT1B1307 Suit Top: IFRETO18	1344W x 700D x 725H	BL PO
OPTION		Fully Assembled		

PART	SHAPE	CODE	DIMENSION	COLOUR
TOP	Rectangle	IFRETO15	1500W x 750D	CB CW GR WT
		IFRETO18	1800W x 900D	
BASE	Side view	IMFOS1TFTB07 Suit Top: IFRETO15	1500 ~ 2100W x 750D x 700H	WT
		IMFOS1TFTB09 Suit Top: IFRETO18	1500 ~ 2100W x 900D x 700H	
OPTION		Fully Assembled		

PART	SHAPE	CODE	DIMENSION	COLOUR
TOP	Rectangle	IFRETO15	1500W x 750D	CB CW GR WT
		IFRETO18	1800W x 900D	
BASE	Side view	IMLE1TB1407 Suit Top: IFRETO15 IFRETO18	1460W x 730D x 690 ~ 775H	WT BL
OPTION		Fully Assembled		

PART	SHAPE	CODE	DIMENSION	COLOUR
TOP	Rectangle	IFRETO15	1500W x 750D	CB CW GR WT
		IFRETO18	1800W x 900D	
BASE	Side view	IMKLF1407 Suit Top: IFRETO15	1450W x 700D x 700H	WT GP
		IMKLF1708 Suit Top: IFRETO18	1750W x 850D x 700H	
OPTION		Fully Assembled		





## MEETING & TRAINING





\*For more Frame Detail Description - Refer to page 44\*

## HOST MOBILE FLIP TABLE



Top: Melamine 25mm Thickness  
 Base: Lockable Heavy Duty PU Swivel Castor  
 Easy to Fold and Stow Away  
 Satin Foot with Black Ripple Pillar  
 \*Table Top Connector Available\*

PART	SHAPE	CODE	DIMENSION	COLOUR
TOP	Rectangle	IFRETO15	1500W x750D	
		IFRETO18	1800W x900D	
BASE	 Side view	IMHOFTB15 Suit Top: IFRETO15	1130W x 640D x 715H	
		IMHOFTB18 Suit Top: IFRETO18	1330W x 640D x 715H	
OPTION	 1 Set of Connector	Fully Assembled Base		
		Drilling of Top to Suit		
		Fitted 2 sets of connector to Top		

## TILTSCOPIC MOBILE FLIP TABLE



Top: Melamine 25mm Thickness  
 Base: Ø60 Lockable Heavy Duty PU Swivel Castor  
 Easy to Fold and Stow Away  
 Telescopic Beam Adjustment  
 \*Table Top Connector Available\*

PART	SHAPE	CODE	DIMENSION	COLOUR
TOP	Rectangle	IFRETO15	1500W x750D	
		IFRETO18	1800W x900D	
BASE	 Side view	IMTSFTB Suit Top: IFRETO15 IFRETO18	1200 ~ 1800W x 550D x 725H	
OPTION	 1 Set of Connector	Fully Assembled Base		
		Fitted 2 sets of connector to Top		

## VOLT FLAP STACKABLE TABLE



Top: Melamine 25mm Thickness  
 Base: Aluminium Cross Base  
 Adjustable Feet

PART	SHAPE	CODE	DIMENSION	COLOUR
TOP	 Round	IFRDTO09	Ø900	
BASE	 Side view	IMVOFLBA Suit Top: IFRDTO09	700W x 700D x 700H	
OPTION		Fully Assembled		











\*For Chair Options - Refer to page 24\*



SCOPE MEETING TABLE





Top: Melamine 25mm Thickness  
Base: 80 x 80mm Column & 580 x 580mm Base

PART	SHAPE	CODE	DIMENSION	COLOUR
TOP		TBSQ0909	900W x 900D	Colours Lead Times Apply
		IFRDT009	Ø900	    
BASE	 Side view	IMSCMTBA Suit Top: TBSQ0909 IFRDT009	580W x 580D x 700H	
OPTION	Fully Assembled			



SCOPE BAR TABLE - SINGLE

Top: Melamine 25mm Thickness  
Base: 80 x 80mm Column & 580 x 580mm Base

PART	SHAPE	CODE	DIMENSION	COLOUR
TOP		TBSQ0606	600W x 600D	Colours Lead Times Apply
		TOPRND07	Ø700	
BASE	 Side view	IMSCMTBA Suit Top: TBSQ0909	580W x 580D x 700H	
OPTION	Fully Assembled			



# Meeting Table

\*For more Frame Detail Description - Refer to page 44\*



VERSE MEETING TABLE

Top: Melamine 25mm Thickness  
Base: Ø76 Column & Ø580 Base

PART	SHAPE	CODE	DIMENSION	COLOUR
TOP	Round	IFRDT009	Ø900	CB CW GR WT RG
		IFRDT012	Ø1200	CB GR WT
BASE	Side view	IMVSMTBA Suit Top: IFRDT009 IFRDT012	Ø580 x 700H	PO
OPTION		Fully Assembled		



VERSE BAR TABLE - SINGLE

Top: Melamine 25mm Thickness  
Base: Ø76 Column & Ø580 Base

PART	SHAPE	CODE	DIMENSION	COLOUR
TOP	Square	TBSQ0606	600W x 600D	Colours Lead Times Apply
	Round	TOPRND07	Ø700	
BASE	Side view	IMSCMTBA Suit Top: TBSQ0909	Ø580 x 1000H	PO
OPTION		Fully Assembled		



VERSE BAR TABLE - DOUBLE

Top: Melamine 25mm Thickness  
Base: Ø76 Column & Ø580 Base

PART	SHAPE	CODE	DIMENSION	COLOUR
TOP	Rectangle	IFRETO15	1500W x 750D	CB CW GR WT
		IFRETO18	1800W x 900D	
BASE	Side view	IMVSBABA Suit Top: IFRETO15 IFRETO18	Ø580 x 1000H	PO
OPTION		Fully Assembled		



SCOPE BAR TABLE - DOUBLE

Top: Melamine 25mm Thickness  
Base: 80 x 80mm Column & 580 x 580mm Base

PART	SHAPE	CODE	DIMENSION	COLOUR
TOP	Rectangle	IFRETO15	1500W x 750D	CB CW GR WT
		IFRETO18	1800W x 900D	
BASE	Side view	IMSCBABA Suit Top: IFRETO15 IFRETO18	580W x 580D x 1000H	BL
OPTION		Fully Assembled		





# Meeting Table

\*For more Frame Detail Description - Refer to page 44\*



## DELTA NOUVEAU 3 LEGS







Top: Melamine 25mm Thickness  
Base: 60 x 15mm Stainless Steel Tube

PART	SHAPE	CODE	DIMENSION	COLOUR
TOP	 Round	IFRDTO09	Ø900	
BASE	 Side view	IMDNMTB3L Suit Top: IFRDTO09	700W x 607D x 725H	
OPTION		Fully Assembled		



## APOLLO







Top: Melamine 25mm Thickness  
Base: 30 x 50mm Aluminium Beam in Black  
Aluminium Die- Casting Leg in Chrome  
Adjustable Feet

PART	SHAPE	CODE	DIMENSION	COLOUR
TOP	 Round	IFRDTO09	Ø900	
		IFRDTO10	Ø1050	
		IFRDTO12	Ø1200	
BASE	 Side view	IMAPMTB0707 Suit Top: IFRDTO09 IFRDTO10 IFRDTO12	700W x 700D x 725H	
OPTION		Fully Assembled		



## SUPREME

Top: Melamine 25mm Thickness  
Base: Ø89 Column Cross Base  
4 Way Cross Base  
Adjustable Feet

PART	SHAPE	CODE	DIMENSION	COLOUR
TOP	 Round	IFRDTO09	Ø900	
		IFRDTO10	Ø1050	
		IFRDTO12	Ø1200	
BASE	 Side view	IMSUMTBA08CR Suit Top: IFRDTO09 IFRDTO10 IFRDTO12	700W x 700D x 705H	
OPTION		Fully Assembled		















\*For more Frame Detail Description - Refer to page 44\*



## DELTA NOUVEAU 4 LEGS













Top: Melamine 25mm Thickness  
Base: 60 x 15mm Stainless Steel Tube

PART	SHAPE	CODE	DIMENSION	COLOUR
TOP		TBSQ0909	900W x 900D	Colours Lead Time Apply
		IFRDT009	Ø900	    
		IFRDT012	Ø1200	  
BASE	 Side view	IMDNMTB4L Suit Top: IFRDT012	700W+ x 700D+ x 725H	 
OPTION		Fully Assembled		



## LETO











Top: Melamine 25mm Thickness  
Base: 25 x 50mm Steel Beam  
Tech Adjustable Height  
\*Beams modified according to requirements\*

PART	SHAPE	CODE	DIMENSION	COLOUR
TOP		IFRDT009	Ø900	    
		IFRDT012	Ø1200	  
BASE	 Side view	IMLE1TB0606 Suit Top: TBSQ0909 IFRDT009	620W x 620D x 690 ~ 775H	 
		IMLE1TB0808 Suit Top: IFRDT012	820W x 820D x 690 ~ 775H	
OPTION	 Caster	Fully Assembled		



## STAR MEETING TABLE

Top: Melamine 25mm Thickness  
Base: Ø76 Column & Ø800 Five Legs  
Heavy Duty Frame

PART	SHAPE	CODE	DIMENSION	COLOUR
TOP		IFRDT009	Ø900	    
		IFRDT012	Ø1200	  
BASE	 Side view	IMSTMTBA Suit Top: IFRDT009 IFRDT012	Ø800 x 700H	
OPTION		Fully Assembled		









# WORKSTATIONS

## Optic Screen

\*For Chair Options - Refer to page 22\*

### VISTA WORKSTATION

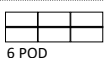
Top: Melamine 25mm Thickness  
 Optic Screen: 13D x 350H- Charcoal fabric

PART	SHAPE	CODE	DIMENSION	COLOUR
TOP	 2 POD	VIS2SYS1515	1500L x 1500D x 725H	   
		VIS2SYS1815	1800L x 1500D x 725H	
	 4 POD	VIS2SYS3015	3000L x 1500D x 725H	
		VIS2SYS3615	3600L x 1500D x 725H	
	 6 POD	VIS2SYS4515	4500L x 1500D x 725H	
		VIS2SYS5415	5400L x 1500D x 725H	
BASE	 20 x 40mm Telescopic Beam Adjustable Feet 6mm Sleek Shadow Line 40 x 70mm Rectangle Tube Side Legs			



\*Screens & Brackets included\*

### OPTIC SCREEN SYSTEM

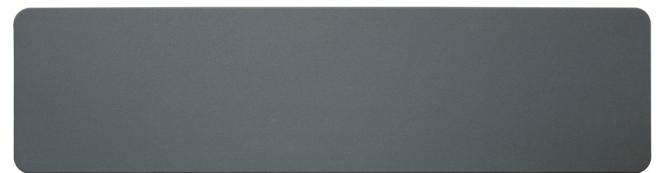
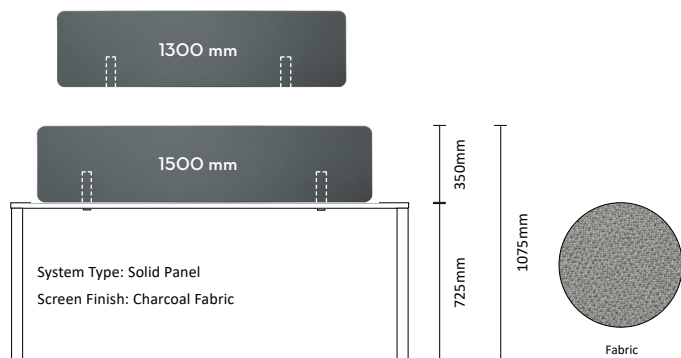

CODE	DIMENSION
SANDWS13	1300W x 13D x 350H
SANDWS15	1500W x 13D x 350H













## Optic Screen

\*For Chair Options - Refer to page 22\*

### PLAZA LINEAR WORKSTATION

Top: Melamine 25mm Thickness  
Optic Screen: 13D x 350H- Charcoal fabric









PART	SHAPE	CODE	DIMENSION	COLOUR
TOP	 4 POD	PLZ4SYS3015	3000L x 1500D x 725H	   
		PLZ4SYS3615	3600L x 1500D x 725H	
	 6 POD	VIS2SYS4515	4500L x 1500D x 725H	
		VIS2SYS5415	5400L x 1500D x 725H	
BASE		20 x 40mm Telescopic Beam Adjustable Feet 6mm Sleek Shadow Line 50mm Square Tube Legs		



\*Screens & Brackets included\*

### FORUM LINEAR WORKSTATION

Top: Melamine 25mm Thickness  
Optic Screen: 13D x 350H- Charcoal fabric

PART	SHAPE	CODE	DIMENSION	COLOUR
TOP	 4 POD	FOR4SYS3015	3000L x 1500D x 725H	   
		FOR4SYS3615	3600L x 1500D x 725H	
	 6 POD	FOR4SYS4515	4500L x 1500D x 725H	
		FOR4SYS5415	5400L x 1500D x 725H	
BASE		20 x 40mm Telescopic Beam Adjustable Feet 6mm Sleek Shadow Line 55mm Triangular Tube Side		



\*Screens & Brackets included\*













## Tek 30 Screen

\*For Chair Options - Refer to page 22\*

### VISTA WORKSTATION

Top: Melamine 25mm Thickness  
 Tek 30 Screen: 32D x 500H - Charcoal Fabric (Included)

PART	SHAPE	CODE	DIMENSION	COLOUR
TOP	 4 POD	VIS2SYS3015	3000L x 1500D x 725H	   
		VIS2SYS3615	3600L x 1500D x 725H	
	 6 POD	VIS2SYS4515	4500L x 1500D x 725H	
		VIS2SYS5415	5400L x 1500D x 725H	
BASE		20 x 40mm Telescopic Beam Adjustable Feet 6mm Sleek Shadow Line 40 x 70mm Rectangle Tube Side Legs		



\*Screens & Brackets included\*

### SCREEN SYSTEM

32mm Charcoal Fabric Screen System  
 System Type: Solid Panel  
 Screen Framework: Powercoat White  
 \* Custom Fabric From:  
 (Rim Trilogy / Laine Suzette) available on request extra

Power / Data Ducting:  
 Ergotek 30 is a non-ducted system, if cabling is required external cabling can be supplied by means of cable baskets fitted under desks with soft-wire leads & outlets.

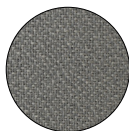

Fabric















## Tek 30 Screen

\*For Chair Options - Refer to page 22\*

### PLAZA LINEAR WORKSTATION (Lead Time Apply 1 - 2 Weeks)

Top: Melamine 25mm Thickness  
Tek 30 Screen: 32D x 500H - Charcoal Fabric (Included)









PART	SHAPE	CODE	DIMENSION	COLOUR
TOP	 4 POD	PLZ4SYS3015	3000L x 1500D x 725H	 
		PLZ4SYS3615	3600L x 1500D x 725H	
	 6 POD	PLZ4SYS4515	4500L x 1500D x 725H	  
		PLZ4SYS5415	5400L x 1500D x 725H	
BASE		20 x 40mm Telescopic Beam Adjustable Feet 6mm Sleek Shadow Line 50mm Square Tube Legs		



\*Screens & Brackets included\*

### FORUM LINEAR WORKSTATION (Lead Time Apply 1 - 2 Weeks)

Top: Melamine 25mm Thickness  
Tek 30 Screen: 32D x 500H - Charcoal Fabric (Included)

PART	SHAPE	CODE	DIMENSION	COLOUR
TOP	 4 POD	FOR4SYS3015	3000L x 1500D x 725H	 
		FOR4SYS3615	3600L x 1500D x 725H	
	 6 POD	FOR4SYS4515	4500L x 1500D x 725H	  
		FOR4SYS5415	5400L x 1500D x 725H	
BASE		20 x 40mm Telescopic Beam Adjustable Feet 6mm Sleek Shadow Line 55mm Triangular Tube Side		



\*Screens & Brackets included\*





# BOARDROOM



## SCOPE

Top: Melamine 25mm Thickness  
 Base: Black Steel Cross Top Arm  
 80 x 80mm Column & 580 x 580mm Base

PART	SHAPE	CODE	DIMENSION	COLOUR
TOP	Rectangle	IFRETO18	1800W x 900D	CB CW GR WT
		TBBR2412	2400W x 1200D	Colours Lead Times Apply
	Boat Shape	IFBOTO24	2400W x 1200D	CW CB
BASE	 Side view	IMSCMTBA Suit Top: IFRETO18 TBBR2412 IFBOTO24	580W x 580D x 700H	BL
OPTION	Fully Assembled			



\*For more Frame Detail Description - Refer to page 44\*



## LETO

Top: Melamine 25mm Thickness  
 Base: Tech Adjustable Height  
 \*Beams modified according to requirements\*

PART	SHAPE	CODE	DIMENSION	COLOUR
TOP	Rectangle	TBBR2412	2400W x 1200D	Colours Lead Times Apply
BASE	 Side view	IMLETB Suit Top: TBBR2412	2050W x 1050D x 690 ~ 775H	WT BL
OPTION	Fully Assembled			



## APOLLO

Top: Melamine 25mm Thickness  
 Base: 30 x 50mm Black Aluminium Black Beam  
 Adjustable Feet

PART	SHAPE	CODE	DIMENSION	COLOUR
TOP	Rectangle	TBBR2412	2400W x 1200D	Colours Lead Times Apply
	Boat Shape	IFBOTO24	2400W x 1200D	CW CB
BASE	 Side view	IMAPBTB2207 Suit Top: TBBR2412 IFBOTO24	2200W x 1000D x 725H	CR
OPTION	Fully Assembled			



## SUPREME

Top: Melamine 25mm Thickness  
 Base: 89Ø Columns  
 Adjustable Feet

PART	SHAPE	CODE	DIMENSION	COLOUR
TOP	Rectangle	TBBR2412	2400W x 1200D	Colours Lead Times Apply
	Boat Shape	IFBOTO24	2400W x 1200D	CW CB
BASE	 Side view	IMSUBA1908 Suit Top: TBBR2412 IFBOTO24	1971W x 800D x 705H	CR
OPTION	Fully Assembled			



## VERSE

Top: Melamine 25mm Thickness  
 Base: Black Steel Cross Top Arm  
 Ø76 Column & Ø580 Base

PART	SHAPE	CODE	DIMENSION	COLOUR
TOP	Rectangle	IFRETO18	1800W x 900D	CB CW GR WT
		TBBR2412	2400W x 1200D	Colours Lead Times Apply
	Boat Shape	IFBOTO24	2400W x 1200D	CW CB
BASE	 Side view	IMVSMTBA Suit Top: IFBOTO24	Ø580 x 700H	PO
OPTION	Fully Assembled			



## DELTA NOUVEAU

Top: Melamine 25mm Thickness  
 Base: 60 x 15mm Stainless Steel Tube

PART	SHAPE	CODE	DIMENSION	COLOUR
TOP	Rectangle	TBBR2412	2400W x 1200D	Colours Lead Times Apply
BASE	 Side view	IMDNBT1B2008 Suit Top: TBBR2412	2033W x 850D x 725H	PO BL
OPTION	Fully Assembled			



TEKTRON EXECUTIVE

Seat: Soft PU  
 Back: Mesh  
 Base: SS Cover 5 Way  
 Seat Height: 455 ~ 575H

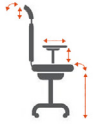

CODE	DIMENSION
ICTEEXLEBL	675W x 630D x 1150 ~ 1270H



MILANO CANTILEVER

Seat: Synthetic Leather  
 Base: Polished Aluminium  
 Seat Height: 475H

CODE	DIMENSION
ICMIGRCASL	580W x 620D x 880H



Mid Black



High Black

MILANO GROUP

Seat: Synthetic Leather  
 Base: Polished Aluminium 5 Way  
 Seat Height: 465 ~ 550H



CODE	DIMENSION
ICMIGR	580W x 630D x 880 ~ 960H 580W x 630D x 1070 ~ 1150H



BERLIN

Seat: Synthetic Leather  
 Base: Polished Aluminium  
 Seat Height: 470H

CODE	DIMENSION
ICBEMBCASL	590W x 590D x 1000H



COBRA

Seat: Genuine Leather  
 Base: Polished Aluminium 5 Way  
 Seat Height: 425 ~ 510H



CODE	DIMENSION
ICCBEXLEBL	660W x 590D x 975 ~ 1055H



BERKELEY

Seat: Genuine Leather  
 Base: Polished Aluminium 5 Way  
 Seat Height: 440 ~ 540H



CODE	DIMENSION
ICBEMBLE	580W x 630D x 880 ~ 960H





TEKTRON DIRECTOR

Seat: Leather  
 Back: Leather  
 Base: SS Cover 5 Way  
 Seat Height: 455 ~ 575H

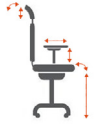

CODE	DIMENSION
ICTEDRLEBL	675W x 630D x 1150 ~ 1270H



High Black



Mid Black

TURIN CANTILEVER

Seat: Synthetic Leather  
 Base: Polished Aluminium  
 Seat Height: 460H

CODE	DIMENSION
ICTUGRCASL	580W x 620D x 880H

TURIN GROUP

Seat: Synthetic Leather  
 Base: Polished Aluminium 5 Way  
 Seat Height: 440 ~ 525H



CODE	DIMENSION
ICTUGR	580W x 630D x 880 ~ 960H
	580W x 630D x 1075 ~ 1150H



KEY TASK

Seat: Fabric Upholstered  
 Back: Mesh  
 Base: Nylon 5 Way  
 Seat Height: 435 ~ 535H



CODE	DIMENSION
ICKYMBMEBL	620W x 580D x 920 ~ 1020H



ELWOOD TASK

Seat: Fabric Upholstered  
 Back: Mesh  
 Base: Polished Aluminium 5 Way  
 Seat Height: 460 ~ 560H



CODE	DIMENSION
ICEWMBMEBL	690W x 600D x 925 ~ 1025H



LINC TASK

Seat: Fabric Upholstered  
 Back: Mesh  
 Base: Nylon (NY)/ Polished Aluminium (AL) 5 Way  
 Seat Height: 440 ~ 570H



CODE	DIMENSION
ICLIMBTABL (NY)	630W x 610D x 880 ~ 1055H
ICLIMBTAPA (AL)	690W x 660D x 910 ~ 1095H



Embossed Pattern

EMBOSS BAR STOOL

BL

Seat & Back: UV Protected Plastic  
 Base: Steel Powder Coated Black Finish  
 Seat Height: 760H

CODE	DIMENSION
ICEMBSBL	515W x 495D x 945H



FINLEY BAR STOOL

BL

Seat & Back: UV Protected Plastic  
 Base: Steel Chrome Finish  
 Seat Height: 760H



CODE	DIMENSION
ICFLBS	480W x 490D x 1000H

FINLEY BAR STOOL

WT

Seat & Back: UV Protected Plastic  
 Base: Steel Chrome Finish  
 Seat Height: 760H



CODE	DIMENSION
ICFLBS	480W x 490D x 1000H



BONN

BL

Seat: Fabric Upholstered Back: Mesh  
 Base: Steel Chrome Finish  
 Seat Height: 450H

CODE	DIMENSION
ICBOVI	550W x 500D x 850H

BONN

OR

Seat: Fabric Upholstered Back: Mesh  
 Base: Steel Chrome Finish  
 Seat Height: 450H

CODE	DIMENSION
ICBOVI	550W x 500D x 850H





Embossed Pattern

**EMBOSS CHAIR**

**BL**

Seat & Back: UV Protected Plastic  
 Base: Steel Powder Coated Black Finish  
 Seat Height: 450H

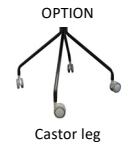

Castor leg



CODE	DIMENSION
ICEMVSBL	550W x 500D x 830H



**FINLEY 4 LEGS**

**WT BL**

Seat & Back: UV Protected Plastic  
 Base: Steel Chrome Finish  
 Seat Height: 450H



CODE	DIMENSION
ICFLTR	570W x 540D x 830H



**FINLEY SLED**

**WT BL**

Seat & Back: UV Protected Plastic  
 Base: Steel Chrome Finish  
 Seat Height: 450H



CODE	DIMENSION
ICFLVS	630W x 540D x 830H



**MAKO**

**BL**

Seat: Blue Grey Fabric Upholstered  
 Back: UV Protected Plastic  
 Base: Steel Chrome Finish  
 Seat Height: 450H



CODE	DIMENSION
ICMATRSCBL	460W x 510D x 845H



ICMOMECH



ICMOSLCH

**MOZZIE**

**CH**

Seat & Back: Fabric Upholstered  
 Base: Steel Powder Coated Black Finish  
 Seat Height: 450H

CODE	DIMENSION
ICMOMECH	450W x 465D x 820H
ICMOSLCH	550W x 500D x 830H



# STORAGE



750W - 2 Holes



900W - 3 Holes



## LUNAR TAMBOUR DOOR CABINET & PLANTER BOX

(WT)

Metal Cabinet: 2 Adjustable Shelves  
Standard Folder Storage Space  
2 Tambour Roller Shutter Doors with Hook Lock



Metal Planter box: 3 Ø200mm Holes for Plant Pots  
Perforated Surface



750W



900W

PART	SHAPE	CODE	DIMENSION	COLOUR
PLANTER BOX		IMLUPB07WT	750W x 450D x 240H	(WT)
		IMLUPBWT	900W x 450D x 240H	
TAMBOUR DOOR CABINET		IMLUTDC3T07WT	750W x 450D x 1095H	(WT)
		IMLUTDC3TWT	900W x 450D x 1095H	
DRACAENA PLANT		DRAPL	Ø55 x 60H (Plant) Ø13 x 11H (Pot)	
OPTION		Fully Assembled	Planter Box Cabinet	





### LUNAR METAL MOBILE PEDESTALS

WT SP CH

- Drawers: 2 Drawers+ 1 File Drawer
- Full Extension Runners
- Master-Key Lock
- 1 Pencil Tray & 1 Divider

- Jockey Wheels
- Removable Barrel Lock System
- \*Fully Assembled\*



CODE	DIMENSION
IMLUMP3L	390W x 500D x 595H



IMLUCAMPR - Right Hand Door

IMLUCAMPL - Left Hand Door

### LUNAR METAL MOBILE CADDY

WT

- Drawers: 2 Drawers+ 1 File Drawer
- Full Extension Runners
- Master-Key Lock
- 1 Pencil Tray & 1 Divider

- Storage Section: 1 Adjustable Shelf
- 1 Tambour Roller Shutter Door with Hook Lock

- Jockey Wheels
- \*Fully Assembled\*

CODE	DIMENSION
IMLUCAMPR	900W x 500D x 595H
IMLUCAMPL	





# EDUCATION

## Desk

### T-LEG STUDENT DESK

\*For more Frame Detail Description - Refer to page 44\*



Top: Round Corners - 18mm Thickness

Base: Tech Height Adjustable 7 Levels

Anit Scratch Zinc- Coated Graphite Ripple Frame

Charcoal Plastic Storage Tub with Rubber Stopper



SDHA0606 - Single Desk



SDHA1206 - Double Desk

CODE	DIMENSION	TUB
SDHA0606	600W x 600D x 560 ~ 800H	1
SDHA1206	1200W x 600D x 560 ~ 800H	2
OPTION	Fully Assembled	

### HOST MOBILE FLIP TABLE

Top: Melamine 25mm Thickness

Base: Lockable Heavy Duty PU Swivel Castor

Easy to Fold and Stow Away

Satin Foot with Black Ripple Pillar

\*Table Top Connector Available\*



PART	SHAPE	CODE	DIMENSION	COLOUR
TOP	Rectangle	IFRETO15	1500W x 750D	
		IFRETO18	1800W x 900D	
BASE	 Side view	IMHOFTB15	1130W x 640D x 715H	
		IMHOFTB18	1330W x 640D x 715H	
OPTION	 Connector	Fully Assembled Base		
		Drilling of Top to Suit		
		Fitted 2 sets of connector to Top		



MOBILE TOTE BOX METAL TROLLEY

Top: Melamine 18mm Thickness

Top Finish:



Base: 25 x 25mm Steel Tube

Anti- scratch Frame

Clear Plastic Boxes

Lockable Heavy Duty PU Swivel Castors

Base Finish:



CODE	DIMENSION	BOX	OPTION
TBTR05	540W x 420D x 873H	5	Fully Assembled
TBTR10	992W x 420D x 873H	10	
TBTR15	1450W x 420D x 873H	15	

Desk

\*For more Frame Detail Description - Refer to page 44\*



K-LITE

Top: Melamine 25mm Thickness

Base: Ø50 Round Steel Tube

20mm x 40mm Steel Beam

Adjustable Feet



QUAD

Top: Melamine 25mm Thickness

Frame: 25 x 25mm Square Steel Tube Legs & Beam

Adjustable Feet

PART	SHAPE	CODE	DIMENSION	COLOUR
TOP	Rectangle	IFRETO15	1500W x 750D	CB CW GR WT
		IFRETO18	1800W x 900D	
BASE	Side view	IMKLF1407	1450W x 700D x 700H	WT GP
		Suit Top: IFRETO15		
		IMKLF1708	1750W x 850D x 700H	
OPTION		Fully Assembled		

PART	SHAPE	CODE	DIMENSION	COLOUR
TOP	Rectangle	IFRETO12	1200W x 600D	GR
BASE	Side view	IMQUFM11	1150W x 550D x 700H	GP
OPTION		Fully Assembled		





Top  
Base



# COLLECTION

## Accent - Desking



### PANEL END DESK

Top: Melamine 25mm Thickness  
Side/ Square Corners: Melamine 25mm Thickness  
Adjustable Feet

CODE	DIMENSION
IFDE1206	1200W x 600D x 725H
IFDE1207	1200W x 750D x 725H
IFDE1507	1500W x 750D x 725H
IFDE1807	1800W x 750D x 725H
IFDE1809	1800W x 900D x 725H
IFDE2109	2100W x 900D x 725H
OPTION	Fully Assembled



### FIXED PANEL END DESK RETURN

Top: Melamine 25mm Thickness  
Side/ Square Corners: Melamine 25mm Thickness  
Adjustable Feet  
Can be Assembled & Fitted to Left or Right Side

CODE	DIMENSION
IFFR0904	900W x 450D x 725H
IFFR0906	900W x 600D x 725H
IFFR1206	1200W x 600D x 725H
OPTION	Fully Assembled



**BOAT SHAPED BOARD TABLE**

Top: Melamine 25mm Thickness  
 Base: Melamine 25mm Thickness  
 Adjustable Feet  
 Double Modesty 'H' Base

CODE	DIMENSION
IFBOTB18	1800W x 900D x 725H
IFBOTB21	2100W x 900D x 725H
IFBOTB24	2400W x 1200D x 725H
OPTION	Fully Assembled



**ROUND TOP TABLE**

Top: Melamine 25mm Thickness  
 Base: Cross Base Melamine 25mm Thickness  
 Adjustable Feet

CODE	DIMENSION
IFRDTA09	Ø900 x 725H
IFRDTA12	Ø1200 x 725H
OPTION	Fully Assembled



**COFFEE TABLE**

Top: Melamine 25mm Thickness  
 Base: Melamine 25mm Thickness  
 Modesty 'H' Base  
 Adjustable Feet  
 Fixed Magazine Shelf

CODE	DIMENSION
IFCFTB0606	600W x 600D x 450H
IFCFTB1206	1200W x 600D x 450H
OPTION	Fully Assembled



**2 PIECE RADIAL WORKSTATION**

Top: Melamine 25mm Thickness  
 Side/ Square Corners: Melamine 25mm Thickness  
 600mm Deep Left or Right Side Return  
 2 Cable Holes & Adjustable Feet

CODE	DIMENSION
IFWSLH	1800W x 750D 1800W x 600D x 725H
IFWSRH	1800W x 750D 1800W x 600D x 725H
OPTION	Fully Assembled



**3 PIECE SPLAY WORKSTATION**

Top: Melamine 25mm Thickness  
 1 Cable Hole  
 Side/ Square Corners: Melamine 25mm Thickness  
 Adjustable Feet

CODE	DIMENSION
IF3PWS1506	1500W x 600D 1500W x 600D x 725H
IF3PWS1806	1800W x 600D 1800W x 600D x 725H
IF3PWS1807	1800W x 750D 1800W x 750D x 725H
OPTION	Fully Assembled

## Accent - Fixed Pedestal



### 2 SMALL DRAWERS

Fixed Storage Unit No Lock  
Fits Under Desk/ Workstation/ 600D Return  
\*Partially Assembled in Carton\*

CODE	DIMENSION
IFFPS	404W x 505D x 297H
OPTION	Fully Assembled



### 1 SMALL DRAWER + 1 FILE DRAWER

Fixed File Storage Unit  
Fits Under Desk/ Workstation/ 600D Return  
Includes Master-Key Lock

CODE	DIMENSION
IFFP2L	404W x 505D x 445H
OPTION	Fully Assembled



### 3 SMALL DRAWERS

Fixed File Storage Unit  
Fits Under Desk/ Workstation/ 600D Return  
Includes Master-Key Lock  
\*Partially Assembled in Carton\*

CODE	DIMENSION
IFFP3L	404W x 505D x 445H
OPTION	Fully Assembled

## Accent - Buffet & Bookcase



### SLIDING DOOR BUFFET

Solid Back + 25mm Top  
Includes Master- Key Lock  
Adjustable Shelves  
Adjustable Feet

CODE	DIMENSION
IFBUSL12 (2 Doors + 2 Shelves)	1200W x 450D x 725H
IFBUSL15 (2 Doors + 2 Shelves)	1500W x 450D x 725H
IFBUSL18 (2 Doors + 2 Shelves)	1800W x 450D x 725H
OPTION	Fully Assembled



### HINGED DOOR BUFFET

Solid Back + 25mm Top  
Includes Master- Key Lock  
Adjustable Shelves  
Adjustable Feet

CODE	DIMENSION
IFBUHGL09 (2 Doors + 1 Shelf + 1 Lock)	900W x 450D x 725H
IFBUHGL18 (4 Doors + 2 Shelves + 2 Locks)	1800W x 450D x 725H
OPTION	Fully Assembled (900W) Fully Assembled (1800W)



### OPEN BOOKCASE

Solid Back + 25mm Top & 18mm Side  
Adjustable Shelves with Cliphook Support  
Adjustable Feet

CODE	DIMENSION
IFBC09 (1 Shelf)	900H x 900W x 300D
IFBC12 (2 Shelves)	1200H x 900W x 300D
IFBC15 (3 Shelves)	1500H x 900W x 300D
IFBC18 (4 Shelves)	1800H x 900W x 300D
IFBCSH	Extra Shelf
OPTION	Fully Assembled



# Accent - Mobile Pedestal & Filing Cabinet



2 SMALL DRAWERS + 1 FILE DRAWER

Mobile Storage Unit  
Includes Master-Key Lock  
\*Partially Assembled in Carton\*

CODE	DIMENSION
IFMP3L	406W x 510D x 670H
OPTION	Fully Assembled



4 SMALL DRAWERS

Mobile Storage Unit  
Includes Master-Key Lock  
\*Partially Assembled in Carton\*

CODE	DIMENSION
IFMP4L	406W x 510D x 670H
OPTION	Fully Assembled



CABINET - 4 FILE DRAWERS

25mm Top/ 18mm Side & Drawer Front  
Full Extension Runners with Adjustable Feet  
Includes Master-Key Lock  
\*Partially Assembled in Carton\*

CODE	DIMENSION
IFFC4L	1200H x 465W x 505D
OPTION	Fully Assembled

# Accent - Cupboard & Hutch



STATIONERY CUPBOARD

Solid Back + 25mm Top & 18mm Side  
2 Full Hinged Doors with Master- Key Lock  
4 Adjustable 25mm Shelves  
Adjustable Feet

CODE	DIMENSION
IFSCLO9	1800H x 900W x 450D
OPTION	Fully Assembled



STORAGE CUPBOARD/ BOOKCASE

Solid Back + 25mm Top & 18mm Side  
2 Half Hinged Doors with Master- Key Lock  
2 Adjustable 25mm Shelves (Bookcase)  
1 Adjustable 25mm Shelf (Cupboard)  
Adjustable Feet

CODE	DIMENSION
IFCPBC	1800H x 800W x 450D
OPTION	Fully Assembled



ADJUSTABLE SHELF HUTCH

Solid Back + 25mm Top & 18mm Side  
Adjustable 25mm Shelves  
Plastic Corner Connectors

CODE	DIMENSION
IFHU09 (2 Shelves)	900W x 300D x 1075H
IFHU12 (4 Shelves)	1200W x 300D x 1075H
IFHU15 (4 Shelves)	1500W x 300D x 1075H
IFHU18 (4 Shelves)	1800W x 300D x 1075H
OPTION	Fully Assembled (900W) Fully Assembled (≥ 1200W)



# COLLECTION

## Accent - Desking



### PANEL END DESK

Top: Melamine 25mm Thickness  
 Side/ Square Corners: Melamine 25mm Thickness  
 Adjustable Feet

CODE	DIMENSION
IFDE1206	1200W x 600D x 725H
IFDE1207	1200W x 750D x 725H
IFDE1507	1500W x 750D x 725H
IFDE1807	1800W x 750D x 725H
IFDE1809	1800W x 900D x 725H
IFDE2109	2100W x 900D x 725H
OPTION	Fully Assembled

### FIXED PANEL END DESK RETURN

Top: Melamine 25mm Thickness  
 Side/ Square Corners: Melamine 25mm Thickness  
 Adjustable Feet  
 Can be Assembled & Fitted to Left or Right Side

CODE	DIMENSION
IFFR0904	900W x 450D x 725H
IFFR0906	900W x 600D x 725H
OPTION	Fully Assembled



## Accent - Table



### BOAT SHAPED BOARD TABLE

Top: Melamine 25mm Thickness  
 Base: Melamine 25mm Thickness  
 Adjustable Feet  
 Double Modesty 'H' Base

CODE	DIMENSION
IFBOTB18	1800W x 900D x 725H
IFBOTB24	2400W x 1200D x 725H
OPTION	Fully Assembled

### ROUND TOP TABLE

Top: Melamine 25mm Thickness  
 Base: Cross Base Melamine 25mm Thickness  
 Adjustable Feet

CODE	DIMENSION
IFRDTA09	∅900 x 725H
OPTION	Fully Assembled

### COFFEE TABLE

Top: Melamine 25mm Thickness  
 Base: Melamine 25mm Thickness  
 Modesty 'H' Base  
 Adjustable Feet  
 Fixed Magazine Shelf

CODE	DIMENSION
IFCFTB0606	600W x 600D x 450H
IFCFTB1206	1200W x 600D x 450H
OPTION	Fully Assembled

## Accent - Workstation



### 2 PIECE RADIAL WORKSTATION

Top: Melamine 25mm Thickness  
 Side/ Square Corners: Melamine 25mm Thickness  
 600mm Deep Left or Right Side Return  
 2 Cable Holes & Adjustable Feet

CODE	DIMENSION
IFWSLH	1800W x 750D 1800W x 600D x 725H
IFWSRH	1800W x 750D 1800W x 600D x 725H
OPTION	Fully Assembled

### 3 PIECE SPLAY WORKSTATION

Top: Melamine 25mm Thickness  
 1 Cable Hole  
 Side/ Square Corners: Melamine 25mm Thickness  
 Adjustable Feet

CODE	DIMENSION
IF3PWS1506	1500W x 600D 1500W x 600D x 725H
IF3PWS1806	1800W x 600D 1800W x 600D x 725H
IF3PWS1807	1800W x 750D 1800W x 750D x 725H
OPTION	Fully Assembled

## Accent - Fixed Pedestal



### 1 SMALL DRAWER + 1 FILE DRAWER

Fixed File Storage Unit  
Fits Under Desk/ Workstation/ 600D Return  
Includes Master-Key Lock

CODE	DIMENSION
IFFP2L	404W x 505D x 445H
OPTION	Fully Assembled



### 3 SMALL DRAWERS

Fixed File Storage Unit  
Fits Under Desk/ Workstation/ 600D Return  
Includes Master-Key Lock  
\*Partially Assembled in Carton\*

CODE	DIMENSION
IFFP3L	404W x 505D x 445H
OPTION	Fully Assembled

## Accent - Buffet & Bookcase



### SLIDING DOOR BUFFET

Solid Back + 25mm Top  
Includes Master- Key Lock  
Adjustable Shelves  
Adjustable Feet

CODE	DIMENSION
IFBUSL12 (2 Doors + 2 Shelves)	1200W x 450D x 725H
IFBUSL15 (2 Doors + 2 Shelves)	1500W x 450D x 725H
IFBUSL18 (2 Doors + 2 Shelves)	1800W x 450D x 725H
OPTION	Fully Assembled



### HINGED DOOR BUFFET

Solid Back + 25mm Top  
Includes Master- Key Lock  
Adjustable Shelves  
Adjustable Feet

CODE	DIMENSION
IFBUHGL09 (2 Doors + 1 Shelf + 1 Lock)	900W x 450D x 725H
OPTION	Fully Assembled



### OPEN BOOKCASE

Solid Back + 25mm Top & 18mm Side  
Adjustable Shelves with Cliphook Support  
Adjustable Feet

CODE	DIMENSION
IFBC09 (1 Shelf)	900H x 900W x 300D
IFBC12 (2 Shelves)	1200H x 900W x 300D
IFBC15 (3 Shelves)	1500H x 900W x 300D
IFBC18 (4 Shelves)	1800H x 900W x 300D
IFBCSH Extra Shelf	
OPTION	Fully Assembled



# Accent - Mobile Pedestal & Filing Cabinet



## 2 SMALL DRAWERS + 1 FILE DRAWER

Mobile Storage Unit  
Includes Master-Key Lock  
\*Partially Assembled in Carton\*

CODE	DIMENSION
IFMP3L	406W x 510D x 670H
OPTION	Fully Assembled



## 4 SMALL DRAWERS

Mobile Storage Unit  
Includes Master-Key Lock  
\*Partially Assembled in Carton\*

CODE	DIMENSION
IFMP4L	406W x 510D x 670H
OPTION	Fully Assembled



## CABINET - 4 FILE DRAWERS

25mm Top/ 18mm Side & Drawer Front  
Full Extension Runners with Adjustable Feet  
Includes Master-Key Lock  
\*Partially Assembled in Carton\*

CODE	DIMENSION
IFFC4L	1200H x 465W x 505D
OPTION	Fully Assembled

# Accent - Cupboard & Hutch



## STATIONERY CUPBOARD

Solid Back + 25mm Top & 18mm Side  
2 Full Hinged Doors with Master- Key Lock  
4 Adjustable 25mm Shelves  
Adjustable Feet

CODE	DIMENSION
IFSCLO9	1800H x 900W x 450D
OPTION	Fully Assembled



## STORAGE CUPBOARD + BOOKCASE

Solid Back + 25mm Top & 18mm Side  
2 Half Hinged Doors with Master- Key Lock  
2 Adjustable 25mm Shelves (Bookcase)  
1 Adjustable 25mm Shelf (Cupboard)  
Adjustable Feet

CODE	DIMENSION
IFCPBC	1800H x 800W x 450D
OPTION	Fully Assembled



## ADJUSTABLE SHELF HUTCH

Solid Back + 25mm Top & 18mm Side  
Adjustable 25mm Shelves  
Plastic Corner Connectors

CODE	DIMENSION
IFHU12 (4 Shelves)	1200W x 300D x 1075H
IFHU15 (4 Shelves)	1500W x 300D x 1075H
IFHU18 (4 Shelves)	1800W x 300D x 1075H
OPTION	Fully Assembled (900W) Fully Assembled (≥ 1200W)



Top  
Base

GR  
GR

# COLLECTION

## Accent - Desking



PANEL END DESK

Top: Melamine 25mm Thickness  
Side/ Square Corners: Melamine 25mm Thickness  
Adjustable Feet

CODE	DIMENSION
IFDE1206	1200W x 600D x 725H
IFDE1207	1200W x 750D x 725H
IFDE1507	1500W x 750D x 725H
IFDE1807	1800W x 750D x 725H
IFDE1809	1800W x 900D x 725H
IFDE2109	2100W x 900D x 725H
OPTION	Fully Assembled



FIXED PANEL END DESK RETURN

Top: Melamine 25mm Thickness  
Side/ Square Corners: Melamine 25mm Thickness  
Adjustable Feet  
Can be Assembled & Fitted to Left or Right Side

CODE	DIMENSION
IFFR0904	900W x 450D x 725H
IFFR0906	900W x 600D x 725H
IFFR1206	1200W x 600D x 725H
OPTION	Fully Assembled



## Accent - Table

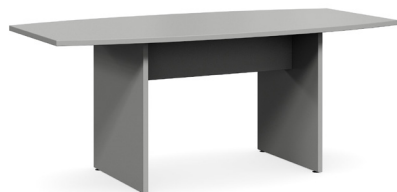

**BOAT SHAPED BOARD TABLE**

Top: Melamine 25mm Thickness  
 Base: Melamine 25mm Thickness  
 Adjustable Feet  
 Double Modesty 'H' Base

CODE	DIMENSION
IFBOTB18	1800W x 900D x 725H
IFBOTB21	2100W x 900D x 725H
OPTION	Fully Assembled



**ROUND TOP TABLE**

Top: Melamine 25mm Thickness  
 Base: Cross Base Melamine 25mm Thickness  
 Adjustable Feet

CODE	DIMENSION
IFRDTA09	Ø1200 x 725H
OPTION	Fully Assembled



**COFFEE TABLE**

Top: Melamine 25mm Thickness  
 Base: Melamine 25mm Thickness  
 Modesty 'H' Base  
 Adjustable Feet  
 Fixed Magazine Shelf

CODE	DIMENSION
IFCFTB0606	600W x 600D x 450H
IFCFTB0806	800W x 600D x 450H
IFCFTB1206	1200W x 600D x 450H
OPTION	Fully Assembled

## Accent - Workstation



**2 PIECE RADIAL WORKSTATION**

Top: Melamine 25mm Thickness  
 Side/ Square Corners: Melamine 25mm Thickness  
 600mm Deep Left or Right Side Return  
 2 Cable Holes & Adjustable Feet

CODE	DIMENSION
IFWSLH	1800W x 750D 1800W x 600D x 725H
IFWSRH	1800W x 750D 1800W x 600D x 725H
OPTION	Fully Assembled



**3 PIECE SPLAY WORKSTATION**

Top: Melamine 25mm Thickness  
 1 Cable Hole  
 Side/ Square Corners: Melamine 25mm Thickness  
 Adjustable Feet

CODE	DIMENSION
IF3PWS1506	1500W x 600D 1500W x 600D x 725H
IF3PWS1806	1800W x 600D 1800W x 600D x 725H
IF3PWS1807	1800W x 750D 1800W x 750D x 725H
OPTION	Fully Assembled

# Accent - Fixed Pedestal



## 2 SMALL DRAWERS

Fixed Storage Unit No Lock  
Fits Under Desk/ Workstation/ 600D Return  
\*Partially Assembled in Carton\*

CODE	DIMENSION
IFFPS	404W x 505D x 297H
OPTION	Fully Assembled



## 1 SMALL DRAWER + 1 FILE DRAWER

Fixed File Storage Unit  
Fits Under Desk/ Workstation/ 600D Return  
Includes Master-Key Lock

CODE	DIMENSION
IFFP2L	404W x 505D x 445H
OPTION	Fully Assembled



## 3 DRAWERS

Fixed File Storage Unit  
Fits Under Desk/ Workstation/ 600D Return  
Includes Master-Key Lock  
\*Partially Assembled in Carton\*

CODE	DIMENSION
IFFP3L	404W x 505D x 445H
OPTION	Fully Assembled

# Accent - Buffet & Bookcase



## SLIDING DOOR BUFFET

Solid Back + 25mm Top  
Includes Master- Key Lock  
Adjustable Shelves  
Adjustable Feet

CODE	DIMENSION
IFBUSL09 (2 Doors + 1 Shelf)	900W x 450D x 725H
IFBUSL12 (2 Doors + 2 Shelves)	1200W x 450D x 725H
IFBUSL15 (2 Doors + 2 Shelves)	1500W x 450D x 725H
IFBUSL18 (2 Doors + 2 Shelves)	1800W x 450D x 725H
OPTION	Fully Assembled (900W) Fully Assembled (≥ 1200W)



## HINGED DOOR BUFFET

Solid Back + 25mm Top  
Includes Master- Key Lock  
Adjustable Shelves  
Adjustable Feet

CODE	DIMENSION
IFBUHGL09 (2 Doors + 1 Shelf + 1 Lock)	900W x 450D x 725H
IFBUHGL18 (4 Doors + 2 Shelves + 2 Locks)	1800W x 450D x 725H
OPTION	Fully Assembled (900W) Fully Assembled (1800W)



## OPEN BOOKCASE

Solid Back + 25mm Top & 18mm Side  
Adjustable Shelves with Cliphook Support  
Adjustable Feet

CODE	DIMENSION
IFBC09 (1 Shelf)	900H x 900W x 300D
IFBC12 (2 Shelves)	1200H x 900W x 300D
IFBC15 (3 Shelves)	1500H x 900W x 300D
IFBC18 (4 Shelves)	1800H x 900W x 300D
IFBCSH	Extra Shelf
OPTION	Fully Assembled



# Accent - Mobile Pedestal & Filing Cabinet



2 SMALL DRAWERS + 1 FILE DRAWER

Mobile Storage Unit  
Includes Master-Key Lock  
\*Partially Assembled in Carton\*

CODE	DIMENSION
IFMP3L	406W x 510D x 670H
OPTION	Fully Assembled



4 SMALL DRAWERS

Mobile Storage Unit  
Includes Master-Key Lock  
\*Partially Assembled in Carton\*

CODE	DIMENSION
IFMP4L	406W x 510D x 670H
OPTION	Fully Assembled



CABINET - 4 FILE DRAWERS

25mm Top/ 18mm Side & Drawer Front  
Full Extension Runners with Adjustable Feet  
Includes Master-Key Lock  
\*Partially Assembled in Carton\*

CODE	DIMENSION
IFFC4L	1200H x 465W x 505D
OPTION	Fully Assembled

# Accent - Cupboard & Hutch



STATIONERY CUPBOARD

Solid Back + 25mm Top & 18mm Side  
2 Full Hinged Doors with Master- Key Lock  
4 Adjustable 25mm Shelves  
Adjustable Feet

CODE	DIMENSION
IFSCLO9	1800H x 900W x 450D
OPTION	Fully Assembled



STORAGE CUPBOARD/ BOOKCASE

Solid Back + 25mm Top & 18mm Side  
2 Half Hinged Doors with Master- Key Lock  
2 Adjustable 25mm Shelves (Bookcase)  
1 Adjustable 25mm Shelf (Cupboard)  
Adjustable Feet

CODE	DIMENSION
IFCPBC	1800H x 800W x 450D
OPTION	Fully Assembled



ADJUSTABLE SHELF HUTCH

Solid Back + 25mm Top & 18mm Side  
Adjustable 25mm Shelves  
Plastic Corner Connectors

CODE	DIMENSION
IFHU09 (2 Shelves)	900W x 300D x 1075H
IFHU12 (4 Shelves)	1200W x 300D x 1075H
IFHU15 (4 Shelves)	1500W x 300D x 1075H
IFHU18 (4 Shelves)	1800W x 300D x 1075H
OPTION	Fully Assembled (900W) Fully Assembled (≥ 1200W)



Top  
Base

**WT  
CG**

# COLLECTION

## Accent - Desking & Workstation



**PANEL END DESK**

Top: Melamine 25mm Thickness  
Side/ Square Corners: Melamine 25mm Thickness  
Adjustable Feet

CODE	DIMENSION
IFDE1507	1500W x 750D x 725H
IFDE1809	1800W x 900D x 725H
OPTION	Fully Assembled



**FIXED PANEL END DESK RETURN**

Top: Melamine 25mm Thickness  
Side/ Square Corners: Melamine 25mm Thickness  
Adjustable Feet  
Can be Assembled & Fitted to Left or Right Side

CODE	DIMENSION
IFFR0906	900W x 600D x 725H
OPTION	Fully Assembled



**3 PIECE SPLAY WORKSTATION**

Top: Melamine 25mm Thickness  
1 Cable Hole  
Side/ Square Corners: Melamine 25mm Thickness  
Adjustable Feet

CODE	DIMENSION
IF3PWS1807	1800W x 750D
	1800W x 750D x 725H
OPTION	Fully Assembled

## Accent - Buffet, Mobile Pestal & Cabinet



SLIDING DOOR BUFFET

Solid Back + 25mm Top  
Includes Master- Key Lock  
Adjustable Shelves  
Adjustable Feet

CODE	DIMENSION
IFBUSL12 (2 Doors + 2 Shelves)	1200W x 450D x 725H
IFBUSL18 (2 Doors + 2 Shelves)	1800W x 450D x 725H
OPTION	Fully Assembled



2 SMALL DRAWERS + 1 FILE DRAWER

Mobile Storage Unit  
Includes Master-Key Lock  
\*Partially Assembled in Carton\*

CODE	DIMENSION
IFMP3L	406W x 510D x 670H
OPTION	Fully Assembled



CABINET - 4 FILE DRAWERS

25mm Top/ 18mm Side & Drawer Front  
Full Extension Runners with Adjustable Feet  
Includes Master-Key Lock  
\*Partially Assembled in Carton\*

CODE	DIMENSION
IFFC4L	1200H x 465W x 505D
OPTION	Fully Assembled

## Accent - Hutch, Bookcase & Cupboard



STATIONERY CUPBOARD

Solid Back + 25mm Top & 18mm Side  
2 Full Hinged Doors with Master- Key Lock  
4 Adjustable 25mm Shelves  
Adjustable Feet

CODE	DIMENSION
IFSCLO9	1800H x 900W x 450D
OPTION	Fully Assembled



OPEN BOOKCASE

Solid Back + 25mm Top & 18mm Side  
Adjustable Shelves with Cliphook Support  
Adjustable Feet

CODE	DIMENSION
IFBC12 (2 Shelves)	1200H x 900W x 300D
IFBC18 (4 Shelves)	1800H x 900W x 300D
IFBCSH	Extra Shelf
OPTION	Fully Assembled



ADJUSTABLE SHELF HUTCH

Solid Back + 25mm Top & 18mm Side  
Adjustable 25mm Shelves  
Plastic Corner Connectors

CODE	DIMENSION
IFHU12 (4 Shelves)	1200W x 300D x 1075H
IFHU18 (4 Shelves)	1800W x 300D x 1075H
OPTION	Fully Assembled



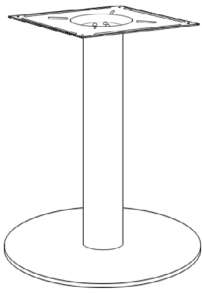

VERSE COFFEE TABLE

Ø63 Column & Ø400 Base  
Black Steel Square Top Plate

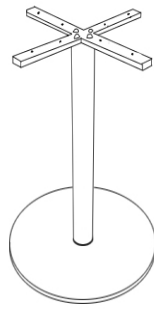

VERSE

Black Steel Cross Top Arm  
Ø76 Column & Ø580 Base

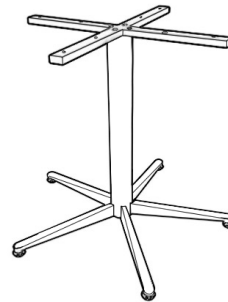

STAR

Black Steel Cross Top Arm  
Ø76 Column & Ø800 Five Legs  
Heavy Duty Frame

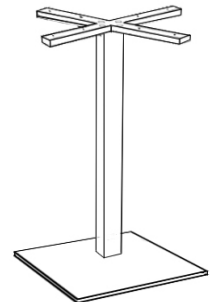

SCOPE

Black Steel Cross Top Arm  
80 x 80mm Column & 580 x  
580mm Base

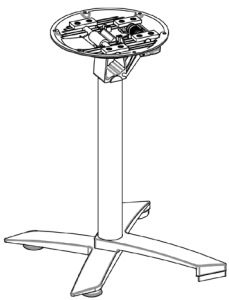

VOLT FLAP

Aluminium Cross Base  
Adjustable Feet  
Stackable Cross Base



DELTA NOUVEAU 4 LEGS

60 x 15mm Stainless Steel Tube  
Black ABS Foot Pads  
Angled Tapered Legs  
4 Way Top Support  
Metal Casting Fastener

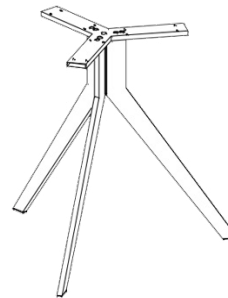

DELTA NOUVEAU 3 LEGS

60 x 15mm Stainless Steel Tube  
Black ABS Foot Pads  
Angled Tapered Legs  
3 Way Top Support  
Metal Casting Fastener

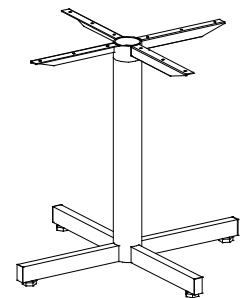

SUPREME

Ø89 Column Cross Base  
Cross Top Support Angles  
4 Way Cross Base  
Adjustable Feet

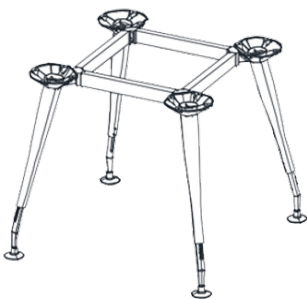

LETO

25 x 50mm Steel Beam  
Tech Height Adjustable  
Angled Shaped Tapered Leg  
\*Beams modified according to requirements\*

Bowl Shaped Top Mounting Plate  
Tech Expansion Fastening  
Extendable Inner Bottom Leg

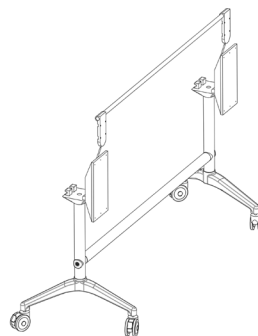

HOST MOBILE FLIP

Satin Foot with Ripple Pillar 740H  
Lockable Heavy Duty PU Swivel Castor  
Foldable & Stow Away  
Tech Adjustable Height  
\*Beams modified according to requirements\*

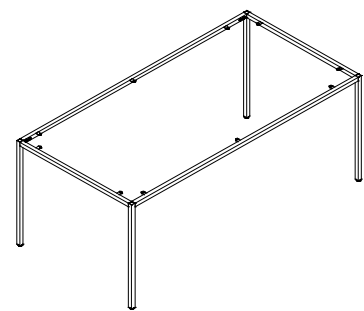

QUAD

25 x 25mm Square Steel Tube Legs & Beam  
Adjustable Feet

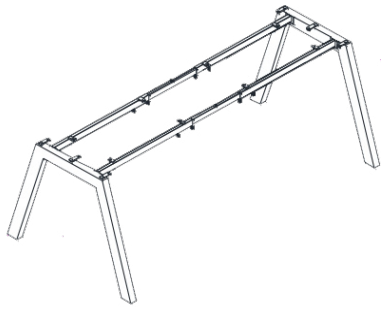

VISTA

20 x 40mm Steel Telescopic Beam  
40 x 70mm Rectangle Tube Side Legs  
6mm Sleek Shadow Line

Adjustable Feet  
Adjustable Width



DIAMOND

70mm X 15~35mm Steel Beam  
Aluminium Connector Chrome  
Adjustable Feet

Beam Edge Angle Shaped  
4 Diamond Shaped Tube Leg

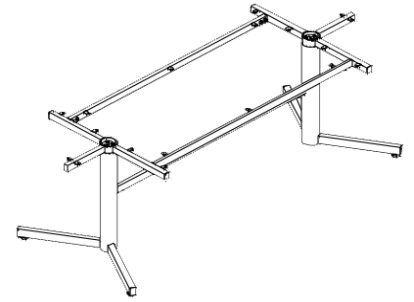

SUPREME

89Ø Columns  
Top Frame in Graphite Ripple

Metal 120° End Side  
Adjustable Feet

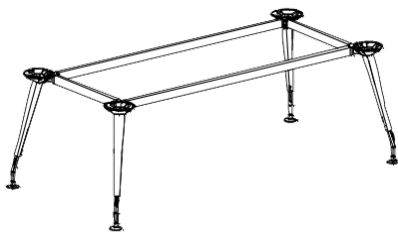

LETO

25 x 50mm Steel Beam  
Tech Height Adjustable  
Angled Shaped Tapered Leg

Bowl Shaped Top Mounting Plate  
Tech Expansion Fastening  
Extendable Inner Bottom Leg

\*Beams modified according to requirements\*

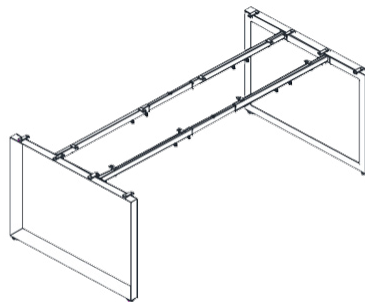

FORUM

20 x 40mm Telescopic Beam  
55mm Triangular Tube Side Legs  
Adjustable Width

6mm Sleek Shadow Line  
Adjustable Feet



APOLLO

30 x 50mm Black Aluminium Black Beam  
Aluminium Die-Casting Leg

Adjustable Feet  
Top Supporters

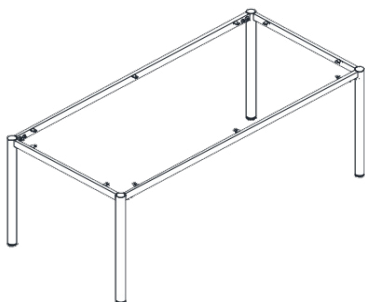

K- LITE

Ø50 Round Steel Tube  
20mm x 40mm Steel Beam  
Adjustable Feet

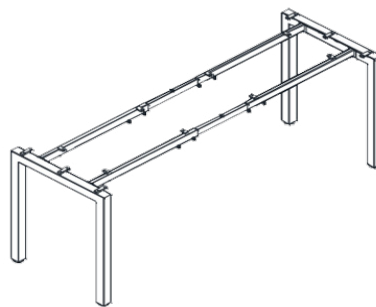

PLAZA

20 x 40mm Telescopic Beam  
50 Square Tube Legs  
6mm Sleek Shadow Line

Adjustable Width  
Adjustable Feet

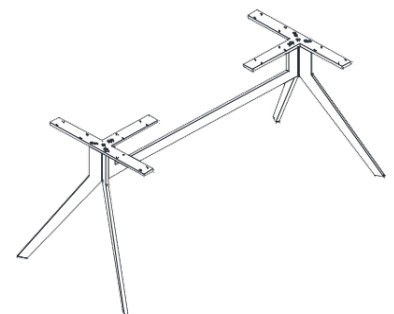

DELTA NOUVEAU

60 x 15mm Stainless Steel Tube  
Angled Tapered Legs  
Metal Casting Fasteners

Black ABS Foot Pads  
U-Shaped Modesty  
T-Way Top Supports

# COLOR SWATCH

## Melamine

**WT** White

**CW** Cherry Wood

**GR** Grey

**CB** Crown Beech

**BU** Steel Blue

**RG** Red Gum

**BL** Black

**IR** Ironstone

**CG** Coal Grey

**PA** Parchment

## Plastic

**WT** White

**BL** Black

## Mesh

**OR** Orange

**BL** Black



---

## Metal

**WT** White

**GP** Graphite Ripple

**SP** Silver Pearls

**BP** Black Ripple

**CR** Chrome

**CH** Charcoal

**PO** Polished Stainless Steel

**BL** Black

---

## Fabric

**BU** Blue

**GR** Grey

**MU** Mustard

**DG** Dark Grey

**CH** Charcoal

**MG** Mid Grey

**SG** Silver Grey

## SELECTRIC THE COMPLETE SOLUTION

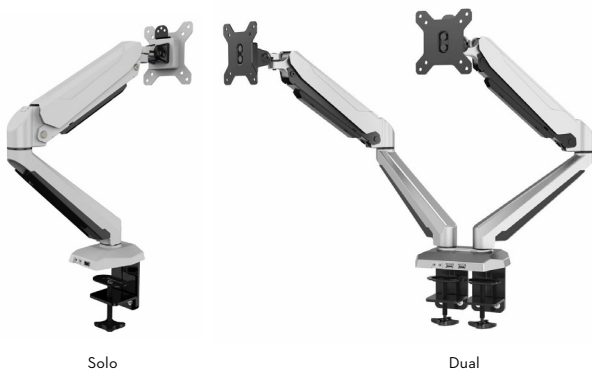
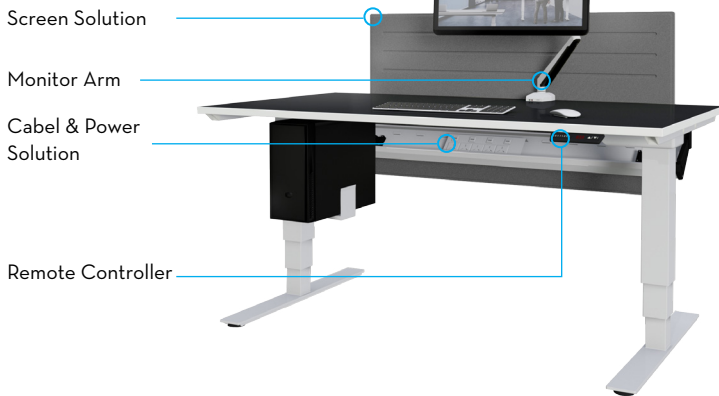
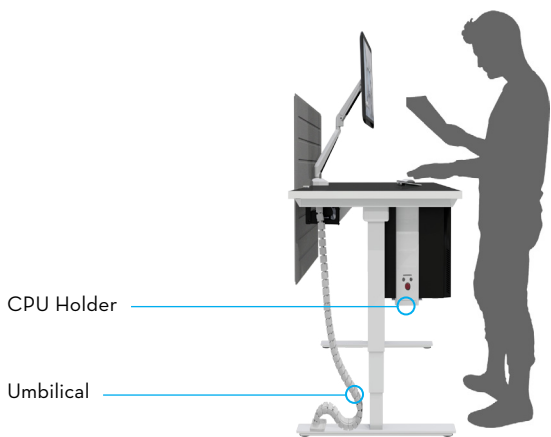

### GMU MONITOR ARM

For Screen Size: 15"~ 17" inch  
 Load: Max 8kg (Per Arm)  
 Swivel: 180° degree Rotation: 360° degree  
 Hidden Cable Management + Angle-free Tilt  
 Fast Insert Function for Monitor  
 USB Port and Headset Plug Intergrated  
 Die Cast Aluminium Structure White Finish  
 Desk Clamp & Grommet Mounting Available

CODE	DIMENSION
IHG MUSOMM (Solo)	570W x 120D x 310H
IHG MUDUMM (Dual)	570W x 120D x 310H



### SONIC ACOUSTIC PANEL

System Type: Acoustic Panel  
 Desk hanging support clamps to suit top

CODE	DIMENSION
SOACPA	1180W x 15D x 700H

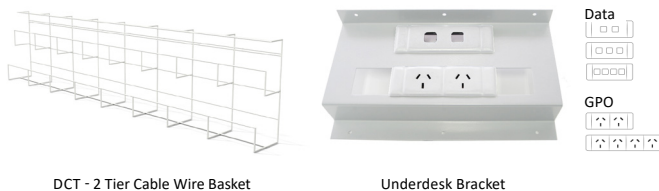

### CABLE MANAGEMENT

CODE	DIMENSION
DCT	750W x 60D x 150H
Underdesk Bracket	300W x 170H

### C1 FIXED CPU HOLDER

Inner Distance 128~248mm Width Adjustable  
 Inner Distance 392~552mm Height Adjustable

CODE	DIMENSION
IMC1CPU	220-275W x 23D x 440-600H

### UMBILICAL

Power & Data Segregated Underdesk Umbilical  
 1300mm Umbilical Cord

CODE	DIMENSION	COLOUR
IMS4LKUBC (S4)	42W x 30D x 1300H	WT
IMSECAUM (S2)	45W x 23D x 1300H	BL

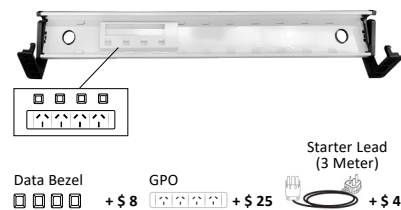

### STRATUM CABLE TRAY

Keeps Cables Neat and Tidy  
 Fitted with Plastic Hanging Bracket & End Cover

CODE	DIMENSION
IMSRFOCT13	1300W x 160D x 98H
IMSRFOCT15	1500W x 160D x 98H

# Single Metal Leg & Table Accessories



IMSTLSP  
Straight Tapered Leg



IMSSLSP  
Shaped Tapered Leg

## SOL - STRAIGHT/ SHAPED TAPERED LEG

SP

Round Tapered Steel Tube  
120w x 120d Square Top Plate

Adjustable Feet

CODE	DIMENSION
IMSTLSP	Ø50 ~ Ø25 x 700H
IMSSLSP	Ø50 ~ Ø25 x 700H
OPTION	Fully Assembled



CR



SP



GP

## SOL POST LEG

Round Tapered Steel Tube  
120w x 120d Square Top Plate

Adjustable Feet

CODE	DIMENSION	COLOUR
IMSOPL	Ø60 x 700H	SP GP CR
OPTION	Fully Assembled	



## SQUARE POST LEG

SP

Round Tapered Steel Tube  
120w x 120d Square Top Plate

Adjustable Feet

CODE	DIMENSION
IMSQPLWT	50W x 50D x 700H
OPTION	Fully Assembled



## ERGO DESK LEG

Steel Mesh Cover in Column

Left & Right change by Universal Assembly



WT



SP



GP

PART	SHAPE	CODE	DIMENSION	COLOUR
TOP	Rectangle	IFRETO15	1500W x 750D	CB CW GR WT
		IFRETO18	1800W x 900D	
BASE	Side view	IMERDL Suit Top: IFRETO15 IFRETO18	680W x 85D x 700H	SP GP WT
OPTION		Fully Assembled		



## CIRCULAR CABLE COVER

Zinc Alloy with Bright Nickel finishing  
Black Brush Seal

CODE	DIMENSION
IHDF8310L	270W x 8D x 28H
OPTION	Fixed to Desk/ Workstation



## RECTANGULAR CABLE OUTLET COVER

Aluminium Anodized

Flexible Brush Seal

Convenient Plug Interface

Easy to Open

CODE	DIMENSION
IHDF8310L	270W x 8D x 28H
OPTION	Fixed to Desk/ Workstation including cutout in desktop

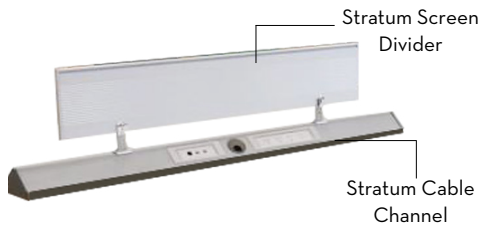

## STRATUM SCREEN DIVIDER

WT

280mm High Above Desk

Accessory Rail On Both Sides

Chrome End Covers & 2 Screen Brackets

2 Joining Plates for Screw Fixing Under Top

CODE	DIMENSION	SUITS TOP
IMSRSD	1200W x 17D x 222H	1500W
	1500W x 17D x 222H	1800W
	1800W x 17D x 222H	2100W
OPTION	Fully Assembled	



## STRATUM CABLE CHANNEL

2 Grey Plastic End Covers & 4 Joining Plates for Screw Fixing

2 Chrome Screen Brackets for Joining of Screen Divider (if required)

2 Cut Out Hole on Both Sides for GPO's/ Data Outlets

\*Does not Include GPO's/ Data Outlets\*

CODE	DIMENSION	SUITS TOP
IMSRCC18AN	1800W x 160D x 85H	1800W
OPTION	Fully Assembled	





ZION FOLDING FRAME - PAIR OF LEGS

Black Adjustable Glides  
 Locking Fitting Engages wgen Folded In & Out  
 \*One Pair Flat-Packed\*

PART	SHAPE	CODE	DIMENSION	COLOUR
TOP	Rectangle	IFRETO15	1500W x750D	CB CW GR WT
		IFRETO18	1800W x900D	
BASE	 Side view	IMZIFOBA Suit Top: IFRETO15 IFRETO18	1100 - 1700W x 560D x 700H	SP
OPTION	Fully Assembled			



3 DRAWERS MOBILE PEDESTAL

PA

Drawer: 2 Small Drawers + 1 File Drawer  
 Includes Master-Key Lock

\* Partially Assembled in Carton\*

CODE	DIMENSION
IFMP3L	406W x 510D x 670H
OPTION	Fully Assembled



MERID METAL MOBILE PEDESTAL

SP

Drawer: 1 Drawer + 1 File Drawer  
 Pencil Tray

Jockey Wheels  
 Removable Barrel System

\* Partially Assembled in Carton\*

CODE	DIMENSION
IMMEMP2LSP	400W x 500D x 515H
OPTION	Fully Assembled







